

JVC



English

COMPACT COMPONENT SYSTEM

组合音响系统

نظام اجهزة صوتية مركبة

中文

CA-MXG950V / CA-MXG880V / CA-MXG850V
CA-MXG780V / CA-MXG750V
CA-MXGA9V / CA-MXGA8V / CA-MXGA7V

عربي

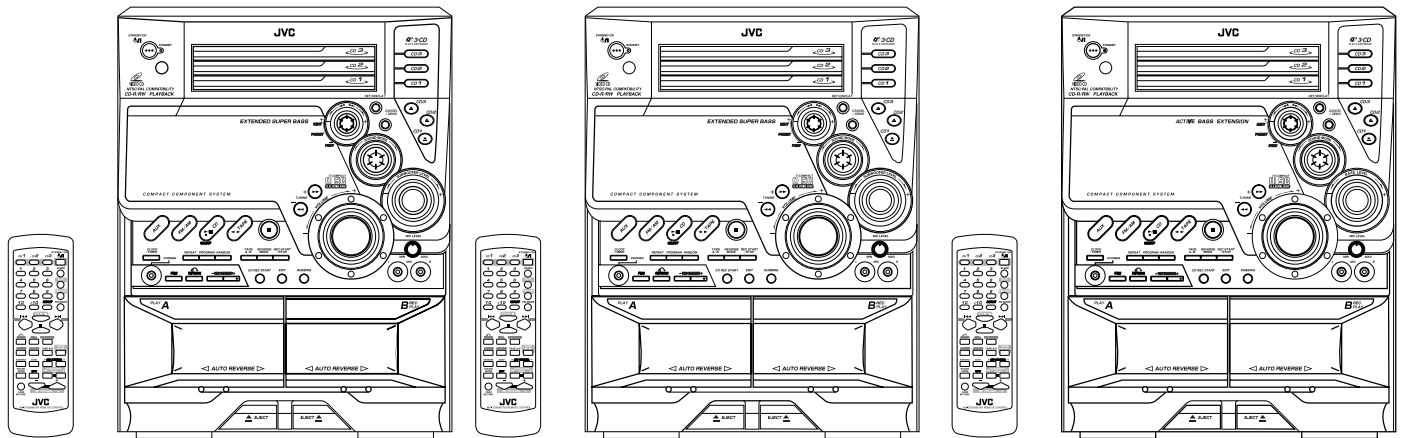

CA-MXG950V
CA-MXGA9V

CA-MXG880V
CA-MXG850V
CA-MXGA8V

CA-MXG780V
CA-MXG750V
CA-MXGA7V

COMPACT
disc
DIGITAL VIDEO

COMPACT
disc
DIGITAL AUDIO

INSTRUCTIONS

使用说明书

كتيب تعليمات التشغيل

For Customer Use:

Enter below the Model No. and Serial No. which are located either on the rear, bottom or side of the cabinet. Retain this information for future reference.

Model No. _____

Serial No. _____

GVT0079-001D
[U, UN, US, UX]

Warnings, Cautions and Others

警告，注意及其他须知事项

تحذيرات، تنبيهات وأشياء أخرى

Caution — STANDBY/ON 0/I button!

Disconnect the mains plug to shut the power off completely. The STANDBY/ON 0/I button in any position does not disconnect the mains line. The power can be remote controlled.

注意 – STANDBY/ON 0/I 开关！

无论 STANDBY/ON 0/I 开关在任何位置，电源线的电源还是没有被切断，若要将电源完全关闭，应把电源插头拔离插座，电源开关可用遥控器控制。

تحذير — STANDBY/ON 0/I الطاقة!

انزع قابس الطاقة الكهربائية من اجل فصل الطاقة الكهربائية عن الجهاز كليا. لا يفصل مفتاح الطاقة الكهربائية عندما يكون باي وضع 0/I STANDBY/ON الطاقة الكهربائية عن الجهاز. يمكن التحكم عن بعد بالطاقة الكهربائية.

CAUTION

To reduce the risk of electrical shocks, fire, etc.:

1. Do not remove screws, covers or cabinet.
2. Do not expose this appliance to rain or moisture.

CAUTION

- Do not block the ventilation openings or holes. (If the ventilation openings or holes are blocked by a newspaper or cloth, etc., the heat may not be able to get out.)
- Do not place any naked flame sources, such as lighted candles, on the apparatus.
- When discarding batteries, environmental problems must be considered and local rules or laws governing the disposal of these batteries must be followed strictly.
- Do not expose this apparatus to rain, moisture, dripping or splashing and that no objects filled with liquids, such as vases, shall be placed on the apparatus.

警告

为了减低触电，火灾等危险：

1. 请勿擅自卸下螺丝钉，盖子或机壳。
2. 切勿让本机受雨淋或置潮湿环境中。

注意

- 请勿堵塞通风口或通风孔。
(如果通风口或通风孔被报纸或布等堵塞，热量将无法散出。)
- 请勿在本设备上放置任何裸露的火源，如点燃的蜡烛。
- 处理废弃电池时，必须考虑环境问题，并严格遵守当地关于处理废弃电池的有关法律或规定。
- 切勿将本装置暴露于雨水所及、潮湿、滴水或易于溅起水花的地方，亦不要将任何装满液体的物件（如花瓶）放置在本装置上。

تحذير

- لا تعق فتحات أو ثقوب التهوية. (إذا تمت اعاققة فتحات أو ثقوب التهوية بواسطة جريدة أو القماش،... الخ، لا يمكن اخراج الحرارة.)
- لا تضع اية مصادر واضحة الالتهاب، مثل الشموع المضيئة، على الجهاز.
- عند رمي البطاريات، يجب الاخذ بنظر الاعتبار المشاكل البيئية والتقيد الكامل بالقواعد المحلية أو قوانين الحكومة المتعلقة بكيفية التخلص من هذه البطاريات.
- لا تعرض هذا الجهاز للمطر، أو الرملية، أو تنقيط الماء، أو رشق لئاء أو السوائل مثل مزهريات الورد على هذا الجهاز.

تحذير

- لتجنب خطر الحريق، الصدمات الكهربائية، الخ:
- 1. لا تقم بفك البراغي، الاغطية أو الخزانة.
- 2. لا تقم بتعرض هذا الجهاز للمطر أو للرطوبة.

REPRODUCTION OF LABELS / 标签内容说明 / إنتاج اللاصقات

① CLASSIFICATION LABEL ON EXTERIOR SURFACE

① 位于机表的分类说明文

① ملصق التصنيف موجود على السطح الخارجي.

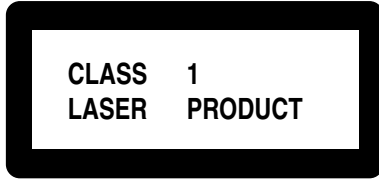

② WARNING LABEL INSIDE THE UNIT

② 位于机内的警告说明文

② ملصق التحذير لدخل الجهاز.

DANGER: Invisible laser radiation when open and interlock failed or defeated. AVOID DIRECT EXPOSURE TO BEAM. (e)	WARNING: Osynlig laserstrålning när denna del är öppen och spärren är urkopplad. Beträkta ej strålen. (s)	ADVARSEL: Usynlig laserstrålning ved åbning, når sikkerhedsafbrydere er ude af funktion. Undgå udsættelse for stråling (d)	VARO: Avattaessa ja suojalukitus ohitettaessa olet alttiina näkymättömälle lasersäteilylle. Älä katso säteeseen. (f)
---	--	---	---

1. CLASS 1 LASER PRODUCT
2. **DANGER:** Invisible laser radiation when open and interlock failed or defeated. Avoid direct exposure to beam.
3. **CAUTION:** Do not open the top cover. There are no user serviceable parts inside the Unit; leave all servicing to qualified service personnel.

1. 一级雷射产品
2. **危险:** 当内部锁定装置失效或者损坏后，打开盖板可能会产生不见的雷射辐射。应避免受到光束直接照射。
3. **注意:** 请勿打开顶盖板，本机内部没有用户可自行维修的部件；所有维修工作应由有资格的人员完成。

١. صنف ١ منتج ليزري
٢. **خطر:** أشعة ليزرية غير مرئية عند الفتح والأغلاق الفاشل أو غير الصحيح. تجنب التعرض المباشر للأشعة.
٣. **تحذير:** لا تفتح الغطاء العلوي. ليس في داخل الجهاز أقسام بمستطاع المستخدم صيانتها؛ إعهد بكافة الأعمال الصيانة لفني مختص.

Caution: Proper Ventilation

To avoid risk of electric shock and fire, and to prevent damage, locate the apparatus as follows:

- 1 Front: No obstructions and open spacing.
- 2 Sides/ Top/ Back: No obstructions should be placed in the areas shown by the dimensions below.
- 3 Bottom: Place on the level surface. Maintain an adequate air path for ventilation by placing on a stand with a height of 10 cm or more.

注意：正确通风

为免发生触电和火警的危险，及防止本机受损，请将本机如下放置：

1. 前面： 没有障碍物及地方开阔。
2. 侧面 / 顶面 / 背面： 在图中所示范围中，不应放置任何障碍物。
3. 底部： 放置在水平面上。放置在一个高 10 厘米或以上的台上，以保持足够的通风道。

تحذير: التهوية الصحيحة

لتجنب حصول صدمات كهربائية واطار الحريق ومنع حصول تلف وضرر للجهاز، ركب الجهاز كما يلي:

١. الجهة الامامية: يجب ان لا يكون هنالك عوائق ويجب ان تكون المنطقة مفتوحة امام الجهاز.
٢. الجهات الجانبية / العلوية / الخلفية: يجب عدم وضع عوائق في المناطق المبينة بالابعاد في الاسفل.
٣. القاعدة: يجب وضع الجهاز على سطح منبسط. اترك مسافة كافية من اجل التهوية بواسطة وضع الجهاز على حامل بارتفاع ١٠ سم او اكثر.

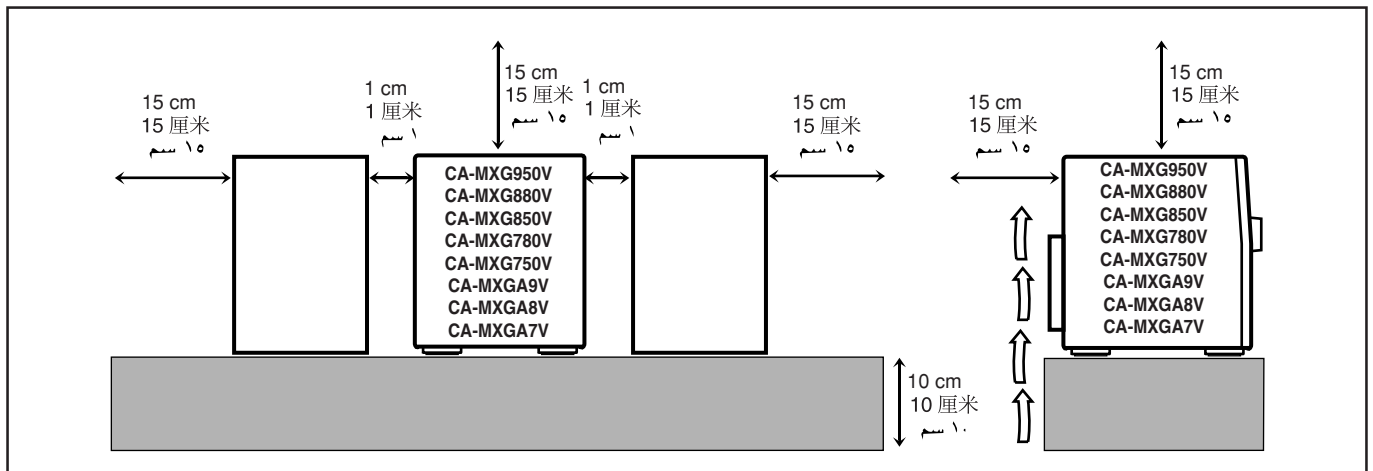

Introduction

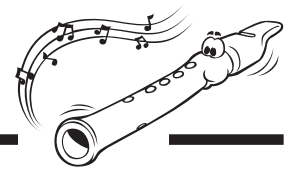

We would like to thank you for purchasing one of our JVC products. Before operating this unit, read this manual carefully and thoroughly to obtain the best possible performance from your unit, and retain this manual for future reference.

About This Manual

This manual is organized as follows:

- The manual mainly explains operations using the buttons and controls on the unit. You can also use the buttons on the remote control if they have the same or similar names (or marks) as those on the unit. If operation using the remote control is different from that using the unit, it is then explained.
- Basic and common information that is the same for many functions is grouped in one place, and is not repeated in each procedure. For instance, we do not repeat the information about turning on/off the unit, setting the volume, changing the sound effects, and others, which are explained in the section “Common Operations” on pages 10 to 12.
- The following marks are used in this manual:



Gives you warnings and cautions to prevent from damage or risk of fire/electric shock. Also gives you information which is not good for obtaining the best possible performance from the unit.



Gives you information and hints you had better know.

Precautions

Installation

- Install in a place which is level, dry and neither too hot nor too cold — between 5°C (41°F) and 35°C (95°F).
- Install the unit in a location with adequate ventilation to prevent internal heat buildup in the unit.
- Leave sufficient distance between the unit and the TV.
- Keep the speakers away from the TV to avoid interference with TV.



DO NOT install the unit in a location near heat sources, or in a place subject to direct sunlight, excessive dust or vibration.

Power sources

- When unplugging from the wall outlet, always pull the plug, not the AC power cord.



DO NOT handle the AC power cord with wet hands.

Moisture condensation

Moisture may condense on the lens inside the unit in the following cases:

- After starting heating in the room
 - In a damp room
 - If the unit is brought directly from a cold to a warm place.
- Should this occur, the unit may malfunction. In this case, leave the unit turned on for a few hours until the moisture evaporates, unplug the AC power cord, and then plug it in again.

Others

- Should any metallic object or liquid fall into the unit, unplug the unit and consult your dealer before operating any further.
- If you are not going to operate the unit for an extended period of time, unplug the AC power cord from the wall outlet.



DO NOT disassemble the unit since there are no user serviceable parts inside.

If anything goes wrong, unplug the AC power cord and consult your dealer.

Which compact discs can be used?

Many types of compact discs are sold for a variety of uses. The player can play the following compact discs:

Video CD discs both with and without PBC

Audio CD discs



Discs you cannot playback

Any other discs than listed above (such as CD-ROM, DVD, CD-G or CD-I Discs) cannot be played. Playing back such discs may generate noise and damage your speakers. Even though a logo listed above is printed on the disc, it may not be played if it is a non-standard disc.

Contents

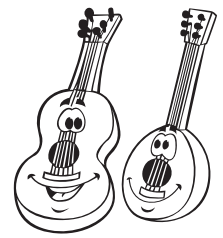

Location of the Buttons and Controls	3	MP3 Disc Playback	22
Remote Control	3	Playing Back Tapes	23
Front Panel	4	Playing Back a Tape	23
Getting Started	6	Locating the Beginning of a Song — Music Scan ...	23
Supplied Accessories	6	Recording	24
Putting the Batteries into the Remote Control	6	Recording a Tape on Deck B	24
Connecting Antennas	6	Dubbing Tapes	25
Connecting Speakers	7	CD Direct Recording	25
Surround Speakers	8	Auto Edit Recording	26
Connecting Other Equipment	9	Using the Microphones	27
Adjusting the Voltage Selector	9	Singing Along — Karaoke	27
Cancelling the Display Demonstration	9	Singing Along with Multiplex Karaoke Discs (MPX)	27
Common Operations	10	Recording Your Singing	28
Turning On or Off the Power	10	Adjust the Music Key Control (for CD play only) ..	28
Setting the Clock	10	Using the Timers	29
Setting the AM Tuner Interval Spacing	10	Using Daily Timer	29
Selecting the Sources	10	Using Recording Timer	31
Adjusting the Volume	11	Using Sleep Timer	32
Reinforcing the Bass Sound	11	Timer Priority	32
Selecting the Sound Modes	11	Maintenance	33
Creating Your Own Sound Mode — Manual Mode	12	Troubleshooting	34
Listening to FM and AM Broadcasts	13	Specifications	35
Tuning in a Station	13		
Presetting Stations	13		
Tuning in a Preset Station	13		
Playing Back CDs (CD/CD-R/CD-RW)	14		
Loading CDs	14		
Playing Back the Entire Discs — Continuous Play	15		
Basic CD Operations	15		
Programming the Playing Order of the Tracks — Program Play	16		
Playing at Random — Random Play	17		
Repeating Tracks or CDs — Repeat Play	17		
Prohibiting Disc Ejection — Tray Lock	17		
Playing Back Video CDs	18		
Selecting Video Output (PAL, MULTI, NTSC)	18		
Loading Discs	18		
Playing a Video CD	18		
Playing Video CDs with PBC Function — Menu Play	19		
Basic Concept of the PBC function	19		
Playing Video CDs without PBC — Continuous Play	20		
Resuming Play	20		
Special Plays for a Video CD	20		
Playing a Multiplex Sound CD	21		

Location of the Buttons and Controls



Remote Control

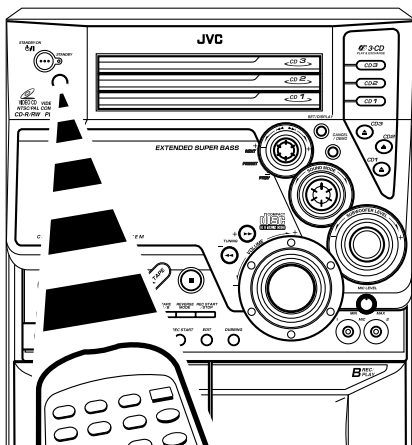
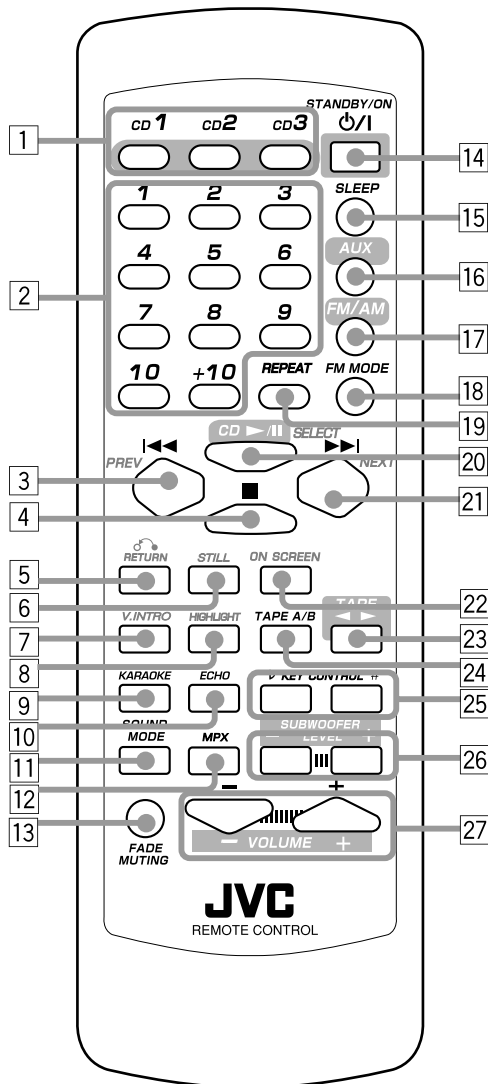

When using the remote control, point it at the remote sensor on the front panel.

Remote Control

- 1 Disc number buttons (CD1, CD2, and CD3) (15 – 16, 22)
Pressing one of these buttons also turns on the unit.
- 2 Number buttons (13, 15 – 16, 19, 21)
- 3 ◀◀ PREV (reverse search) button (13, 15 – 17, 19 – 20, 22, 23)
- 4 ■ (stop) button (15 – 23)
- 5 ↶ RETURN button (19)
- 6 STILL button (20)
- 7 V.INTRO button (20)
- 8 HIGHLIGHT button (21)
- 9 KARAOKE button (22, 27)
- 10 ECHO button (27)
- 11 SOUND MODE button (11)
- 12 MPX button (21, 27 – 28)
- 13 FADE MUTING button (11)
- 14 STANDBY/ON ⏻ button (10, 30 – 31)
- 15 SLEEP button (32)
- 16 AUX button (10)
Pressing this button also turns on the unit.
- 17 FM/AM button (10, 13)
Pressing this button also turns on the unit.
- 18 FM MODE button (13)
- 19 REPEAT button (16 – 17, 22)
- 20 CD ▶/|| SELECT button (10, 15, 18 – 20, 22, 28)
Pressing this button also turns on the unit.
- 21 ▶▶ NEXT (forward search) button (13, 15 – 17, 19 – 20, 22, 23)
- 22 ON SCREEN button (20, 22)
- 23 TAPE ◀▶ button (10, 23 – 24)
Pressing this button also turns on the unit.
- 24 TAPE A/B button (23)
- 25 Ⓚ KEY CONTROL # button (28)
- 26 SUBWOOFER LEVEL + / – buttons (11)
(For CA-MXG950V/G880V/G850V/GA9V/GA8V)
BASS LEVEL + / – buttons (11) (For CA-MXG780V/
G750V/GA7V)
- 27 VOLUME + / – buttons (11, 27 – 28)

Become familiar with the buttons and controls on your unit.

Front Panel

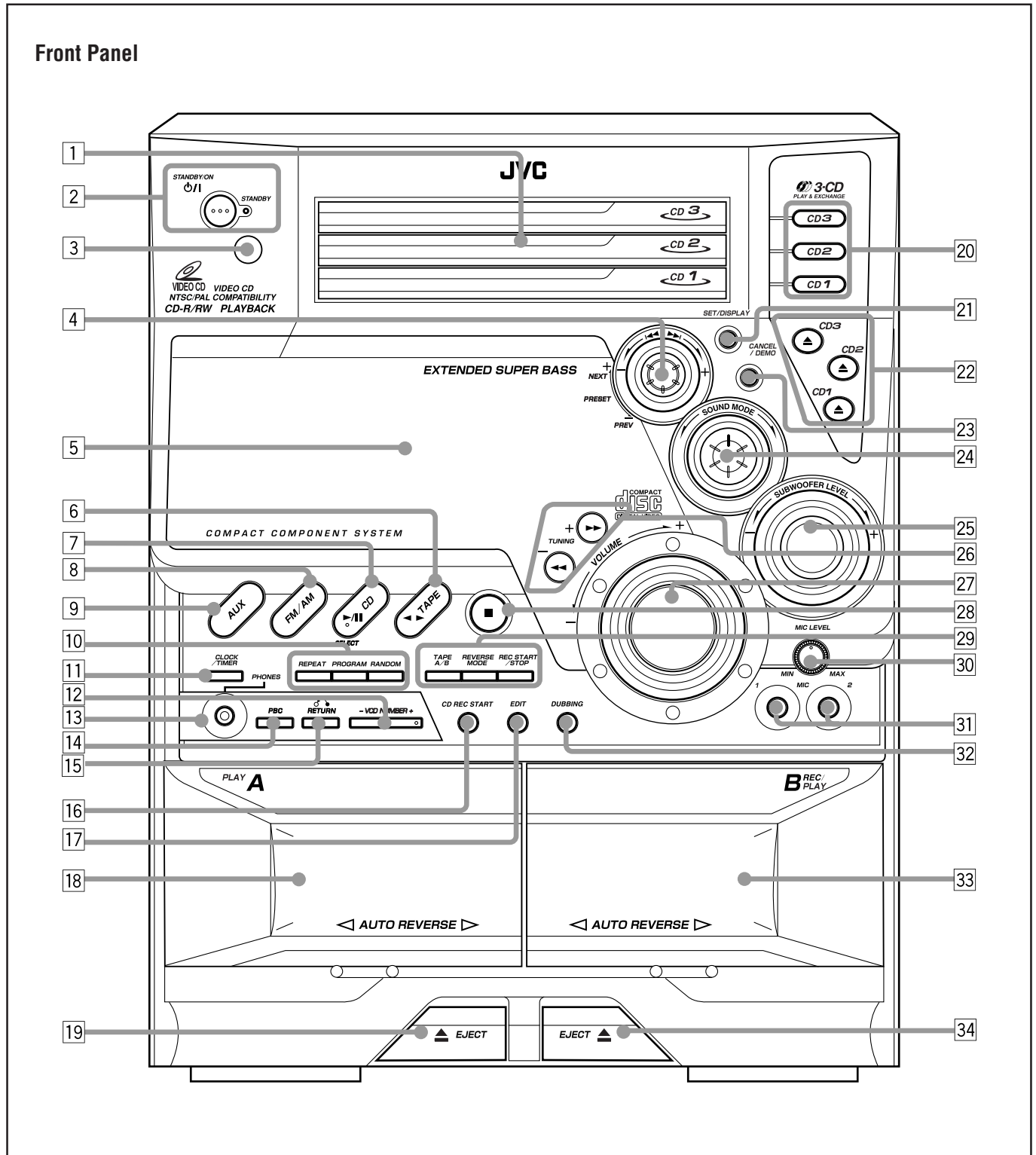

Notes:

1. CA-MXG950V/G880V/G850V/GA9V/GA8V: EXTENDED SUPER BASS
CA-MXG780V/G750V/GA7V: ACTIVE BASS EXTENSION
2. CA-MXG950V/G880V/G850V/GA9V/GA8V: SUBWOOFER LEVEL
CA-MXG780V/G750V/GA7V: BASS LEVEL
3. All illustrations in this manual will be based on CA-MXG950V/G880V/G850V/GA9V/GA8V

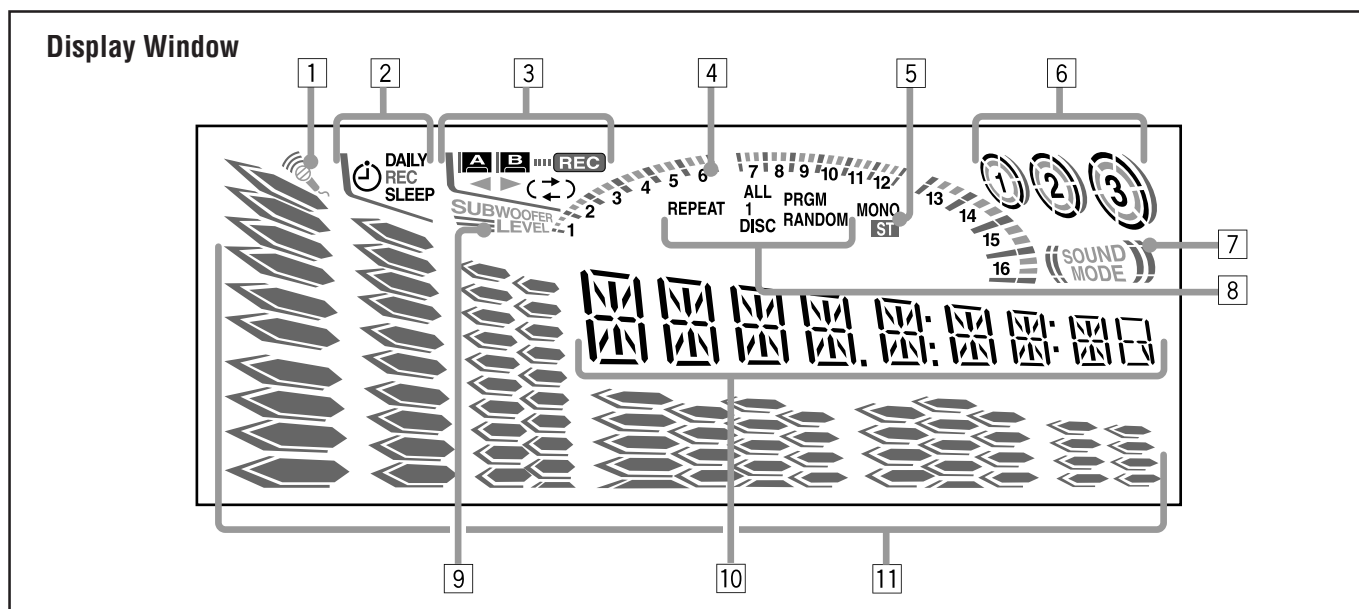

See pages in the parentheses for details.

Front Panel

- 1 Disc trays
- 2 STANDBY/ON ⏻ /I button and STANDBY lamp (10, 30, 31)
- 3 Remote sensor
- 4 PRESET +/- NEXT/PREV control
 ◀◀ / ▶▶ (reverse search/forward search) (10, 12 – 13, 15 – 17, 22, 26, 29 – 31)
- 5 Display window
- 6 TAPE ◀▶ button and lamp (10, 23 – 25)
Pressing this button also turns on the unit.
- 7 CD ▶|| SELECT (play/pause) button and lamp (10, 15 – 20, 22, 26, 28)
Pressing this button also turns on the unit.
- 8 FM/AM button and lamp (10, 13)
Pressing this button also turns on the unit.
- 9 AUX button and lamp (10)
Pressing this button also turns on the unit.
- 10 CD play mode buttons
 - REPEAT button (16, 17, 22)
 - PROGRAM button (16, 22)
 - RANDOM button (17, 22)
- 11 CLOCK/TIMER button (10, 29 – 32)
- 12 VCD NUMBER +/- button (19)
- 13 PHONES jack (11)
- 14 PBC button (19, 20)
- 15 ↶ RETURN button (19)
- 16 CD REC START button (25 – 26)
- 17 EDIT button (26)
- 18 Deck A cassette holder (23)
- 19 ▲ EJECT button for deck A (23)
- 20 Disc number buttons and lamps (CD1, CD2, and CD3) (15 – 16, 18, 20, 21, 25)
Pressing one of these buttons also turns on the unit.
- 21 SET/DISPLAY button (10, 12 – 13, 16, 22, 26, 29 – 32)
- 22 ▲ (Disc tray open/close) (CD1, CD2, and CD3) buttons (14 – 15, 17 – 18)
Pressing one of these buttons also turns on the unit.

- 23 CANCEL/DEMO button (9, 10, 16, 22, 26, 29 – 32)
- 24 SOUND MODE control (11)
- 25 SUBWOOFER LEVEL +/- control (11)
 (For CA-MXG950V/G880V/G850V/GA9V/GA8V)
 BASS LEVEL +/- control (11) (For CA-MXG750V/G780V/GA7V)
- 26 TUNING +/- buttons (13)
 ◀◀ / ▶▶ (fast left/fast right) buttons (12, 15, 23)
- 27 VOLUME +/- control (11, 27, 28)
- 28 ■ (stop) button (10, 15 – 26, 28, 31)
- 29 Tape operation buttons
 - TAPE A/B button (23)
 - REVERSE MODE button (23, 25 – 26)
 - REC START/STOP button (24 – 26, 28, 31)
- 30 MIC LEVEL control (27 – 28)
- 31 MIC 1 and MIC 2 jacks (27)
- 32 DUBBING button (25)
- 33 Deck B cassette holder (24)
- 34 EJECT ▲ button for deck B (23, 24)

Display Window

- 1 Karaoke (🎤) and echo (🔊) indicators
- 2 Timer indicators
 - ⌚ (Timer), DAILY (Daily Timer), REC (Recording Timer), and SLEEP (Sleep Timer) indicators
- 3 Tape operation indicators
 - A/B (operating deck), **REC** (recording), ◀▶ (tape direction), and ↶ (reverse mode) indicators
- 4 CD track number (1 – 16) indicators
- 5 Tuner operation indicators
 - MONO and ST (stereo) indicators
- 6 Disc indicators
- 7 SOUND MODE indicator
- 8 CD play mode indicators
 - REPEAT (ALL/1/DISC), PRGM (program), and RANDOM indicators
- 9 SUBWOOFER LEVEL indicator
 (For CA-MXG950V/G880V/G850V/GA9V/GA8V)
 LEVEL indicator (For CA-MXG780V/G750V/GA7V)
- 10 Main display
 - Shows the source name, frequency, etc.
- 11 Audio level indicator

Getting Started



Supplied Accessories

Make sure that you have all the following items. The number in the parentheses indicates the quantity of the pieces supplied.

- AM loop antenna (1)
- FM antenna (1)
- Remote control (1)
- Batteries (2)
- AC plug adaptor (1)
- Video cord (1)

If anything is missing, consult your dealer immediately.

Putting the Batteries into the Remote Control

Insert the batteries — R6(SUM-3)/AA(15F) — into the remote control, by matching the polarity (+ and –) on the batteries with the + and – markings on the battery compartment.

When the remote control can no longer operate the unit, replace both batteries at the same time.

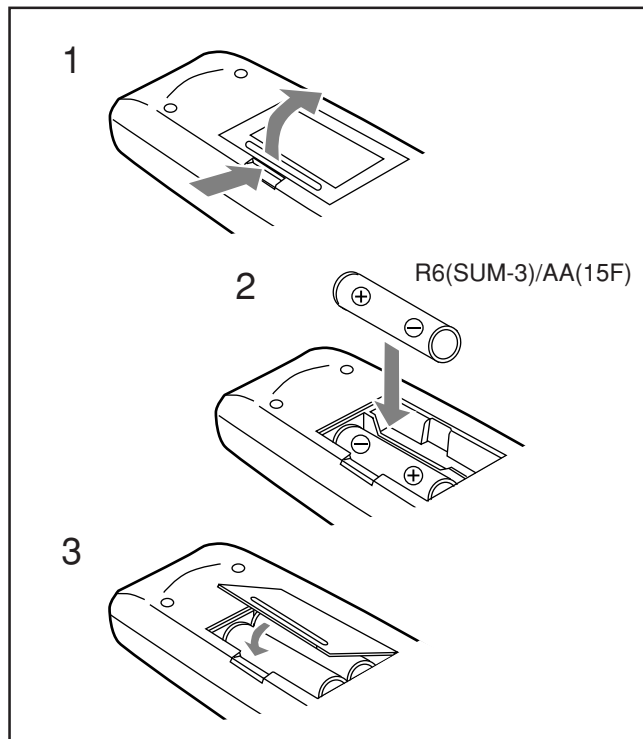

- DO NOT use an old battery together with a new one.
- DO NOT use different types of batteries together.
- DO NOT expose batteries to heat or flame.
- DO NOT leave the batteries in the battery compartment when you are not going to use the remote control for an extended period of time. Otherwise, it will be damaged from battery leakage.

Connecting Antennas

FM antenna

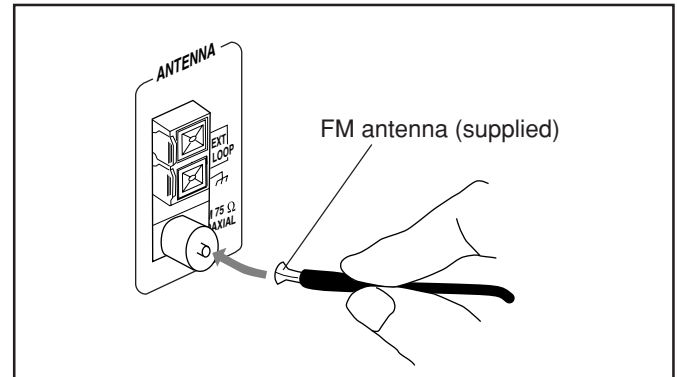

- 1 Attach the FM antenna to the FM 75 Ω COAXIAL terminal.
- 2 Extend the FM antenna.
- 3 Fasten it up in the position which gives you the best reception, then fix it on the wall, etc.



About the supplied FM antenna

The FM antenna supplied with this unit can be used as temporary measure. If reception is poor, you can connect an outdoor FM antenna.

To connect an outdoor FM antenna

Before connecting it, disconnect the supplied FM antenna.

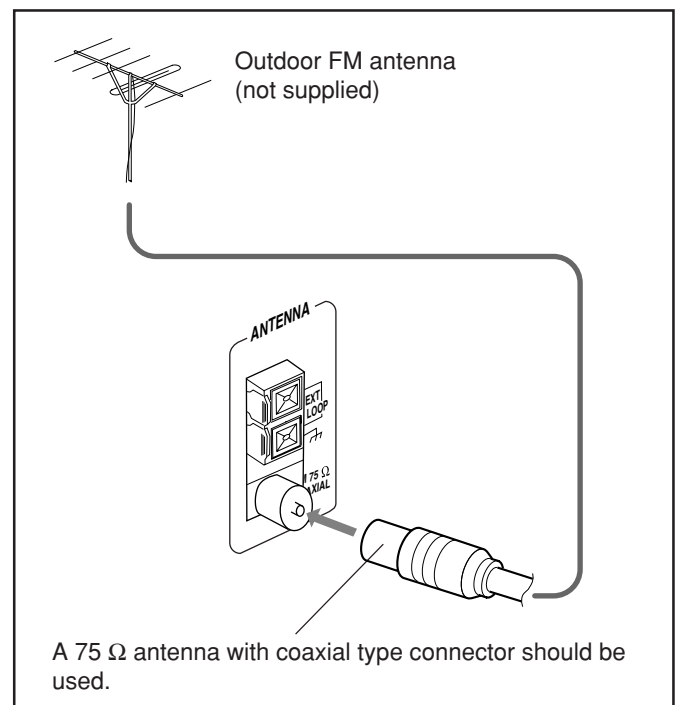

AM antenna

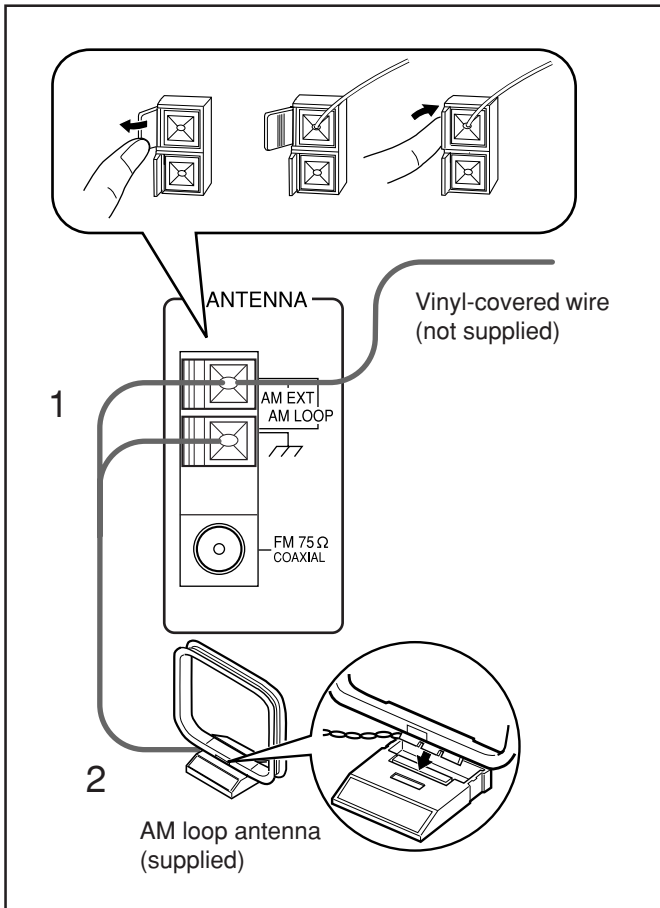

1 Connect the AM loop antenna to the AM LOOP terminals as illustrated.

- If the AM loop antenna wire is covered with vinyl, remove the vinyl by twisting it as shown in the diagram.

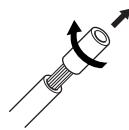

2 Turn the AM loop antenna until you have the best reception.

To connect an outdoor AM antenna

When reception is poor, connect a single vinyl-covered wire to the AM EXT terminal and extend it horizontally. The AM loop antenna must remain connected.



For better reception of both FM and AM

- Make sure the antenna conductors do not touch any other terminals and connecting cords.
- Keep the antennas away from metallic parts of the unit, connecting cords, and the AC power cord.

Connecting Speakers

For CA-MXG950V/G880V/G850V/GA9V/GA8V

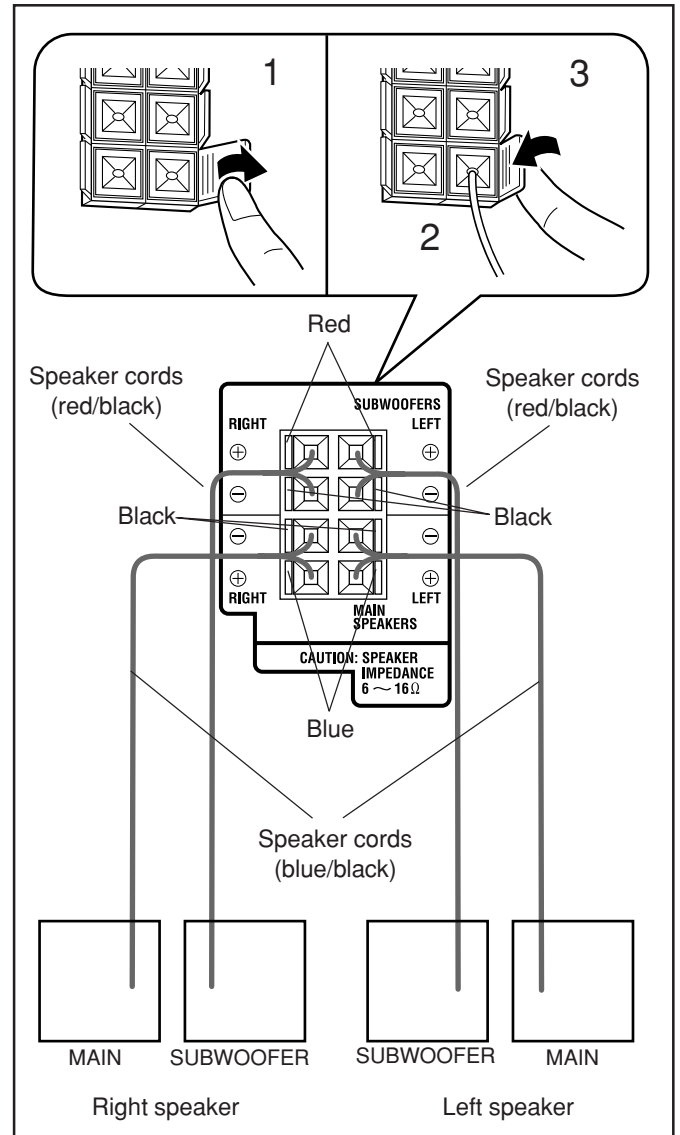

1 Open the speaker terminals on the rear of the unit.

2 Insert the end of the speaker cord into the terminal.

Match the polarity (colours) of the speaker terminals: Red (+) to red (+) and black (-) to black (-); Blue (+) to blue (+) and black (-) to black (-).

3 Close the speaker terminals.

IMPORTANT: Use only speakers with the same speaker impedance as indicated by the speaker terminals on the rear of the unit.



- DO NOT connect more than one speaker to each speaker terminal.
- DO NOT push or pull the speakers as this will damage the foot spacers at the bottom of the speakers.

For CA-MXG780V/G750V/GA7V

Surround Speakers

To connect surround speakers.

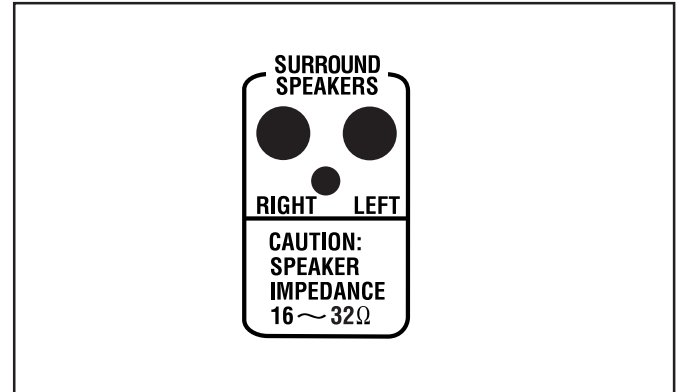
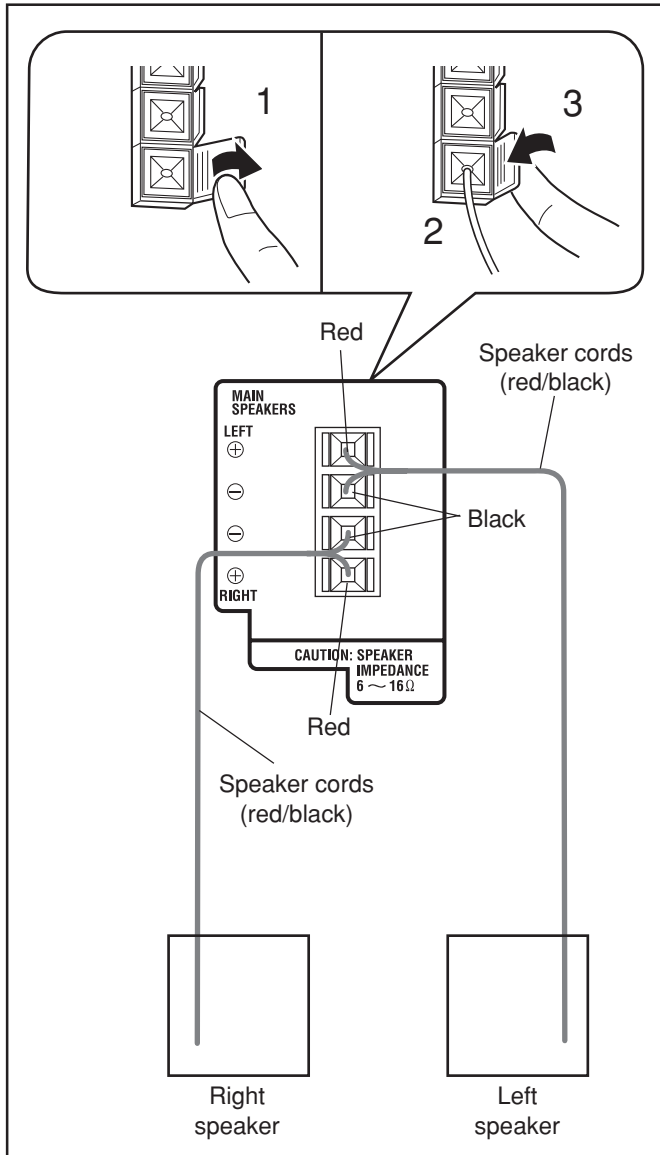

- Connect the right rear speaker to the RIGHT jack.
- Connect the left rear speaker to the LEFT jack.

1 Open the speaker terminals on the rear of the unit.

2 Insert the end of the speaker cord into the terminal.

Match the polarity (colours) of the speaker terminals: Red (+) to red (+) and black (-) to black (-).

3 Close the speaker terminals.

IMPORTANT: Use only speakers with the same speaker impedance as indicated by the speaker terminals on the rear of the unit.



- DO NOT connect more than one speaker to each speaker terminal.
- DO NOT push or pull the speakers as this will damage the foot spacers at the bottom of the speakers.

Connecting Other Equipment

You can connect both analog and digital equipment.



- DO NOT connect any equipment while the power is on.
- DO NOT plug in any equipment until all connections are complete.

To connect an analog component

Be sure that the plugs of the audio cords are coloured: White plugs and jacks are for left audio signals, and red ones for right audio signals.

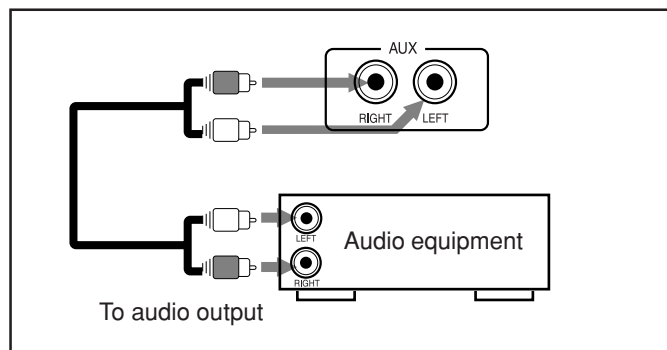

For playing the other equipment through this unit, connect between the audio output jacks on the other equipment and AUX jacks by using audio cords (not supplied).

To connect audio equipment with an optical digital input terminal

You can record CD sound onto the connected digital equipment.

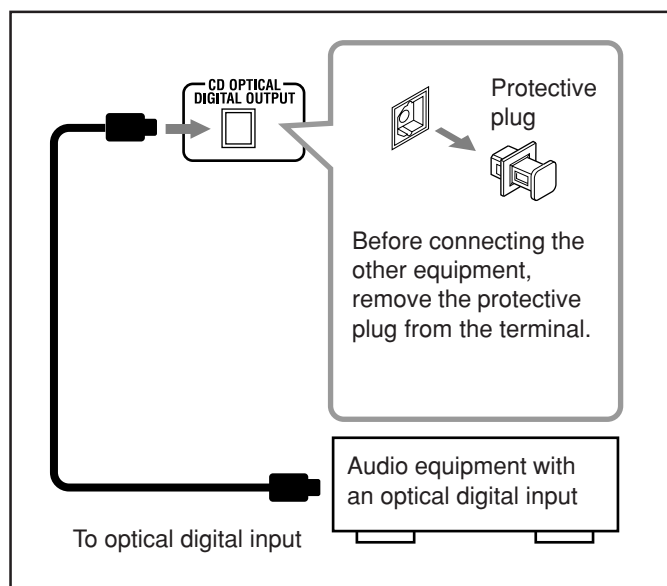

Connect an optical digital cord (not supplied) between the optical digital input terminal on the other equipment and the CD OPTICAL DIGITAL OUTPUT terminal.

Adjusting the Voltage Selector

Before plugging in the unit, set the correct voltage for your area with the voltage selector on the rear of the unit.

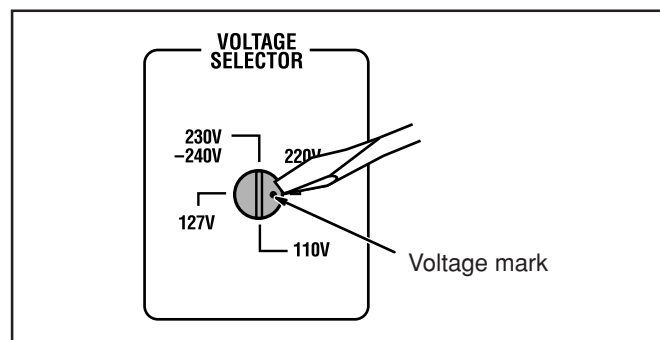

Use a screwdriver to rotate the voltage selector so the voltage number the voltage mark is pointing at is the same as the voltage where you are plugging in the unit. (See the back cover page.)



- DO NOT plug in before setting the voltage selector on the rear of the unit and all connection procedures are complete.

Now, you can plug in the AC power cord.

When connecting the AC power cord to a wall outlet, the unit automatically starts display demonstration.

- If the wall outlet does not match the AC plug, use the supplied AC plug adaptor.

IMPORTANT: Be sure to check all connections to be done before plugging the AC power cord into a wall outlet.

Cancelling the Display Demonstration

On the unit ONLY:

To cancel the display demonstration, press CANCEL/DEMO until "DEMO OFF" appears on the display.



When you press other buttons

The display demonstration stops temporarily. It will start automatically again (if no operation is done for 2 minutes) unless you cancel it by pressing CANCEL/DEMO.

To start the display demonstration manually

Press and hold CANCEL/DEMO again for more than 1 second.

Common Operations

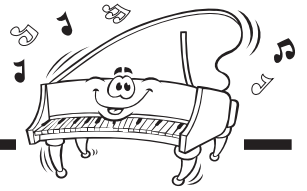

Turning On or Off the Power

To turn on the unit, press STANDBY/ON so that the STANDBY lamp goes off.

WELCOME

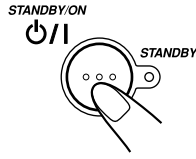

To turn off the unit (on standby), press STANDBY/ON again so that the STANDBY lamp lights up.

GOODBYE

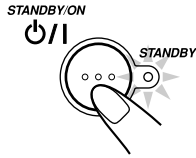

- A little power is always consumed even while the unit is on standby.

To switch off the power supply completely, unplug the AC power cord from the AC outlet.



When you unplug the AC power cord or if a power failure occurs

The clock is reset to "0:00" right away, while the tuner preset stations (see page 13) will be erased in a few days.

Setting the Clock

Before operating the unit any further, first set the built in clock. You can set the clock whether the unit is on or off.

On the unit ONLY:

1 Press CLOCK/TIMER.

The hour digits start flashing on the display.



2 Turn to adjust the hour, then press SET/DISPLAY.

The minute digits start flashing on the display.

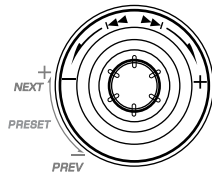

SET/DISPLAY

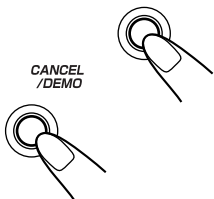

- If you want to correct the hour after pressing SET/DISPLAY, press CANCEL/DEMO. The hour digits start flashing again.

3 Turn to adjust the minute, then press SET/DISPLAY.

CLOCK OK

To check the clock time

Press and hold SET/DISPLAY while playing any source.

- Each time you press and hold the button, the source indication and the clock time alternate on the display.

To adjust the clock again

If you have adjusted the clock before, you need to press CLOCK/TIMER repeatedly until the clock setting mode is selected.

- Each time you press the button, the clock/timer setting modes change as follows:

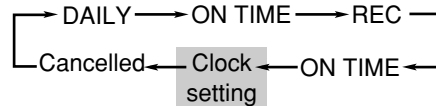

(The hour digits start flashing.)



When you unplug the AC power cord or if a power failure occurs

The clock loses the setting and is reset to "0:00." You need to set the clock again.

Setting the AM Tuner Interval Spacing

Some countries space AM stations 9 kHz apart, and some countries use 10 kHz spacing.

On the unit ONLY:

You can only change the AM tuner interval spacing while tuning into an AM station. (See page 13.)

Press STANDBY/ON while holding down .

- Each time you press these buttons, the AM tuner interval spacing alternates between 9 kHz and 10 kHz.

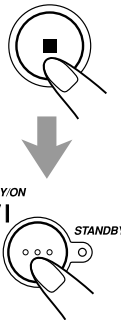

Selecting the Sources

To listen to the FM/AM broadcasts, press FM/AM.

(See page 13.)

To playback CDs, press CD SELECT. (See pages 14 – 17.)

To playback tapes, press TAPE . (See page 23.)

To select the external equipment as the source, press AUX.

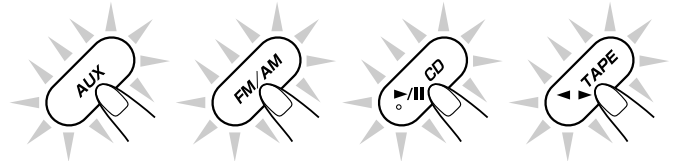

When you press the play button for a particular source (FM/AM, CD SELECT, TAPE and AUX), the unit turns on (and the unit starts playing the source if it is ready — COMPU PLAY CONTROL).



About the audio level indicator

All the audio level indicators light up when no signals come in.

Adjusting the Volume

You can adjust the volume level only while the unit is turned on. The volume level can be adjusted in 32 steps (VOL MIN, VOL 01 — VOL 30 and VOL MAX).

Turn **VOLUME + / -** clockwise (+) to increase the volume or counterclockwise (-) to decrease it.

VOL 15

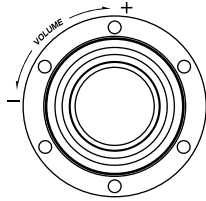

When using the remote control, press **VOLUME +** to increase the volume or press **VOLUME -** to decrease it.



For private listening

Connect a pair of headphones to the PHONES jack. No sound comes out of the speakers. Be sure to turn down the volume before connecting or putting on headphones.



DO NOT turn off (on standby) the unit with the volume set to an extremely high level; otherwise, a sudden blast of sound can damage your hearing, speakers and/or headphones when you turn on the unit or start playing any source next time. **REMEMBER** you cannot adjust the volume level while the unit is on standby.

To turn down the volume level temporarily

Press **FADE MUTING** on the remote control. The volume level gradually decreases to "VOL MIN."



To restore the sound, press the button again.

Reinforcing the Bass Sound (For CA-MXG950V/G880V/G850V/GA9V/GA8V)

You can select one of the 4 subwoofer levels. This function only affects the playback sound, but does not affect your recording. The subwoofer level can be adjusted in 4 steps — LEVEL 1, LEVEL 2, LEVEL 3 and LEVEL 4 (MAX LEVEL).

Turn **SUBWOOFER LEVEL + / -** clockwise (+) to increase the subwoofer sound or counterclockwise (-) to decrease it.

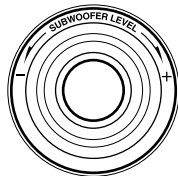

When using the remote control, press **SUBWOOFER LEVEL +** to increase the subwoofer volume or press **SUBWOOFER LEVEL -** to decrease it.

SUBWOOFER indicator always lights up when the unit is on.

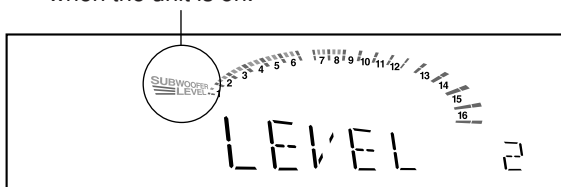

Reinforcing the Bass Sound (For CA-MXG780V/G750V/GA7V)

You can select one of the 4 bass levels. This function only affects the playback sound, but does not affect your recording. The bass levels can be adjusted in 4 steps — BASS OFF, BASS 1, BASS 2 and BASS 3.

Turn **BASS LEVEL + / -** clockwise (+) to increase the bass sound or counterclockwise (-) to decrease it.

When using the remote control, press **BASS LEVEL +** to increase the bass volume or press **BASS LEVEL -** to decrease it.



LEVEL indicator always lights up when the unit is on.

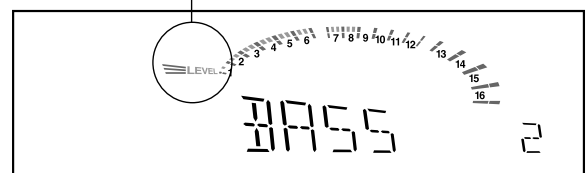

Selecting the Sound Modes

You can select one of the 6 preset sound modes (3 surround modes and 3 SEA — Sound Effect Amplifier — modes). This function only affects the playback sound, but does not affect your recording.

To select the sound modes, turn **SOUND MODE** (or press **SOUND MODE** on the remote control) until the sound mode you want appears on the display.

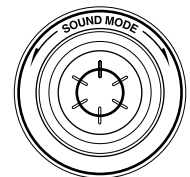

The **SOUND MODE** indicator also lights up on the display.

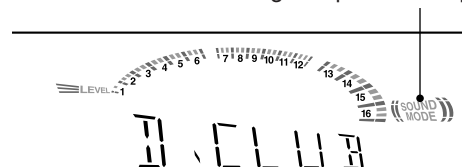

The sound modes change as follows:

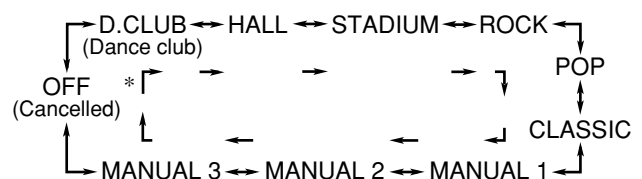

* When using the remote control, the sound mode changes in only one direction.

Surround modes**:

D.CLUB: Increases resonance and bass.

HALL: Adds depth and brilliance to the sound.

STADIUM: Adds clarity and spreads the sound, like in an outdoor stadium.

SEA (Sound Effect Amplifier) modes:

ROCK: Boosts low and high frequency. Good for acoustic music.

POP: Good for vocal music.

CLASSIC: Good for classical music.

Manual modes:

MANUAL 1/2/3:

Your individual mode stored in memory. See “Creating Your Own Sound Mode — Manual Mode” on page 12.

OFF: The sound mode is cancelled. The SOUND MODE indicator goes off.

** Surround elements are added to the SEA elements to create a being-there feeling in your room.

When one of these modes is selected, the SOUND MODE indicator lights up as — 

While one of the SEA modes including manual modes (SEA elements without surround elements) is selected, the SOUND MODE indicator lights up as — 

Creating Your Own Sound Mode — Manual Mode

You can change SEA patterns to suit your preference. These changed settings can be stored in the MANUAL 1, MANUAL 2 and MANUAL 3 modes.

- There is a time limit in performing the following steps. If the setting is cancelled before you finish, start from step 1 again.

On the unit ONLY:

1 Select one of the preset sound modes.

- If you want to add the surround elements in your SEA pattern, select one of the surround modes (D.CLUB, HALL, or STADIUM) before starting the procedure below. (See “Selecting the Sound Modes” on page 11.)

SET/DISPLAY



2 Press and hold SET/DISPLAY until “SEA CONT” appears on the display.



Current level appears.

3 Adjust the SEA pattern.

1) Turn  to select the frequency range to adjust (LOW, MID, HIGH).

2) Press  or  to adjust the level (-3 to +3) of the selected frequency range.

3) Repeat steps 1) and 2) to adjust the level of the other frequency ranges.

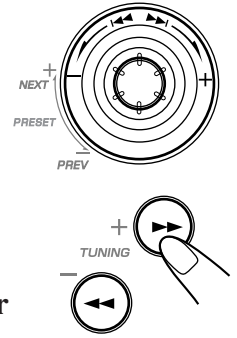

4 Press SET/DISPLAY again.

SET/DISPLAY

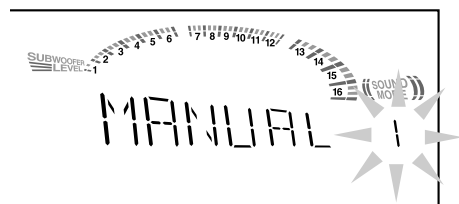

5 Turn to select one of the MANUAL 1, MANUAL 2 and MANUAL 3 modes into which you want to store the SEA pattern.

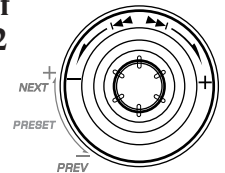

6 Press SET/DISPLAY again.

SET/DISPLAY

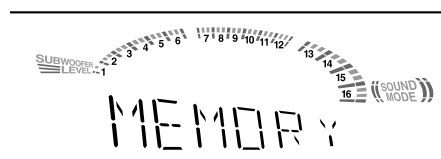

The SEA pattern you have created are stored into the MANUAL mode selected in the above step.

To use your own sound mode

Select MANUAL 1, MANUAL 2, or MANUAL 3 mode when using the sound modes. See “Selecting the Sound Modes” on page 11.



notes When you unplug the AC power cord or if a power failure occurs

The setting will be erased in a few days. If this happens, set the manual sound modes again.

Listening to FM and AM Broadcasts



Tuning in a Station

1 Press FM/AM.

The unit automatically turns on and tunes in the previously tuned station (either FM or AM).
 • Each time you press the button, the band alternates between FM and AM.



2 Start searching for stations.

On the unit:
 Press and hold TUNING + or TUNING - for more than 1 second.

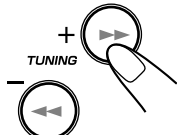

On the remote control:
 Press and hold ►► NEXT or ◀◀ PREV for more than 1 second.

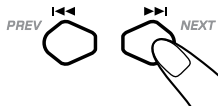

The unit starts searching for stations and stops when a station of sufficient signal strength is tuned in.
 • If a program is broadcast in stereo, the ST (stereo) indicator lights up.

To stop searching, press TUNING + or TUNING - (or ►► NEXT/◀◀ PREV on the remote control).



When you press TUNING + or TUNING - (or ►► NEXT/◀◀ PREV on the remote control) briefly and repeatedly the frequency changes step by step.

To change the FM reception mode

When an FM stereo broadcast is hard to receive or noisy, press FM MODE on the remote control so that the MONO indicator lights up on the display. Reception improves.



To restore the stereo effect, press FM MODE again so that the MONO indicator goes off. In this stereo mode, you can hear stereo sounds when a program is broadcasted.

Presetting Stations

You can preset 30 FM and 15 AM stations.

In some cases, test frequencies have been already memorized for the tuner since the factory examined the tuner preset function before shipment. This is not a malfunction. You can preset the stations you want into memory by following the presetting method.

• There is a time limit in performing the following steps. If the setting is cancelled before you finish, start from step 1 again.

On the unit ONLY:

1 Tune in the station you want to preset.
 • See “Tuning in a Station.”

2 Press SET/DISPLAY.



SET/DISPLAY



3 Turn ◀◀/▶▶ to select a preset number.

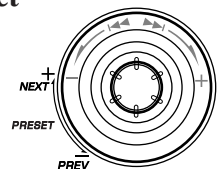

4 Press SET/DISPLAY again.



SET/DISPLAY



The tuned station in step 1 is stored in the preset number selected in step 3.

• Storing a new station on a used number erases the previously stored one.



When you unplug the AC power cord or if a power failure occurs

The preset stations will be erased in a few days. If this happens, preset the stations again.

Tuning in a Preset Station

1 Press FM/AM.

The unit automatically turns on and tunes in the previously tuned station (either FM or AM).

• Each time you press the button, the band alternates between FM and AM.



2 Select a preset number.

On the unit:

Turn ◀◀/▶▶.

On the remote control:

Press the number buttons.

- Ex.: For preset number 5, press 5.
 For preset number 15, press +10, then 5.
 For preset number 20, press +10, then 10.
 For preset number 25, press +10, +10, then 5.
 For preset number 30, press +10, +10, then 10.

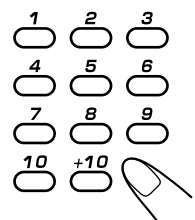
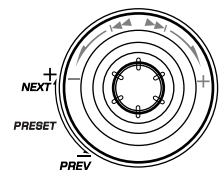

Playing Back CDs (CD/CD-R/CD-RW)



This unit has been designed to playback the following CDs:

- CD (Audio CD)
- CD-R (CD-Recordable)
- CD-RW (CD-ReWritable)

Continued use of irregular shape CDs (heart-shape, octagonal, etc.) can damage the System.

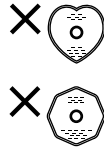

General Notes

In general, you will have the best performance by keeping your CDs and the mechanism clean.

- Store CDs in their cases, and keep them in cabinets or on shelves.
- Keep the system's disc trays closed when not in use.

When playing a CD-R or CD-RW

User-edited CD-Rs (CD-Recordable) and CD-RWs (CD-ReWritable) can be played back only if they are already "finalized."

- You can playback your original CD-Rs or CD-RWs recorded in music CD format. (However, they may not be played back depending on their characteristics or recording conditions.)
- Before playing back CD-Rs or CD-RWs, read their instructions or cautions carefully.
- Some CD-Rs or CD-RWs may not be played back on this unit because of their disc characteristics, damage or stain on them, or the player's lens is dirty.
- CD-RWs may require a longer read-out time. This is caused by the fact that the reflectance of CD-RWs is lower than for regular CDs.

Loading CDs

On the unit ONLY:

- 1 Press **▲** for the disc tray (CD1, CD2 and CD3) you want to load a CD onto.

The unit automatically turns on and the disc tray comes out.

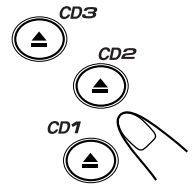

- 2 Place a disc correctly on the circle of the disc tray, with its label side up.

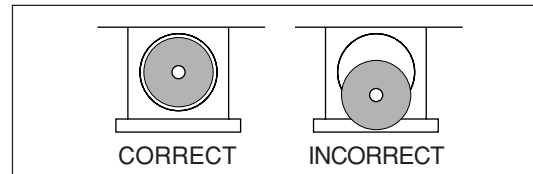

- When using a CD single (8 cm), place it on the inner circle of the disc tray.

- 3 Press the same **▲** you have pressed in step 1.

The disc tray closes, and the corresponding disc number lamp and disc indicator light up on the display (CD1, CD2, and CD3).

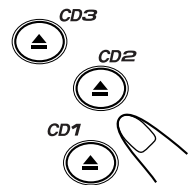

- 4 Repeat steps 1 to 3 to place other CDs.



When loading more than one CD continuously

When you press **▲** for the next tray you want to place another CD onto, the first disc tray automatically closes and then the next tray comes out.



About the disc indicators

Each disc indicator corresponds to the disc tray of the same number.

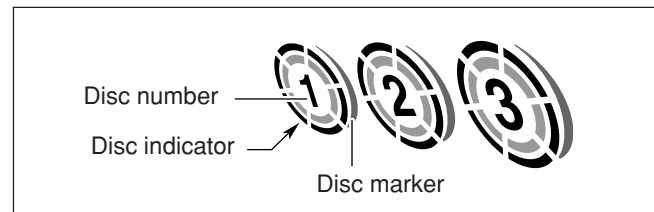

- The disc marker lights up for the disc number you have selected.
- The disc indicator flashes while the corresponding CD is being played.
- The disc indicator goes off when the unit has detected that there is no CD on the corresponding disc tray.

Playing Back the Entire Discs — Continuous Play

1 Load CDs.

2 Press one of the disc number buttons (CD1, CD2 and CD3) for the disc you want to play.

CD play starts from the first track of the selected disc and the disc number lamp starts flashing.

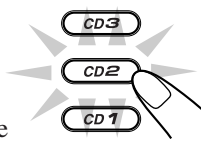

Tracks of the currently playing disc
(Track numbers exceeding 16 are not displayed.)

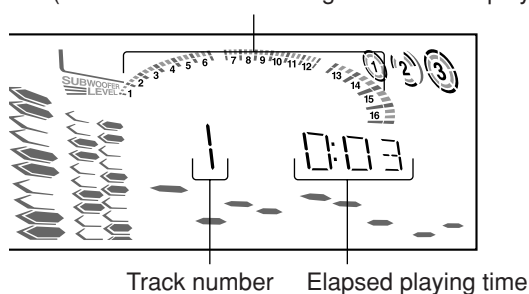

- Pressing CD ►/|| SELECT instead of the disc number buttons starts playing back if a CD is on the trays.
- If no CD is placed on the selected disc tray, "NO DISC" appears on the display.

To stop playing, press ■.

To remove the disc, press ▲ for the corresponding disc tray.



CD playback sequence

When 3 CDs* are loaded on the disc trays, they are played in one of the following sequences.

- When CD1 is pressed: CD1 ⇒ CD2 ⇒ CD3 (then stops)
- When CD2 is pressed: CD2 ⇒ CD3 ⇒ CD1 (then stops)
- When CD3 is pressed: CD3 ⇒ CD1 ⇒ CD2 (then stops)

* When only 2 CDs are loaded, they are played in the same order, but the disc tray without a CD is skipped.



Total Number of Contents (TOC) reading

STOP button does not function during CD changing time and TOC reading (about 10-20 seconds). You can press STOP button only after playing time start counting on the display.

Basic CD Operations

While playing a CD, you can do the following operations.

To exchange CDs during playback of another

Press ▲ corresponding to a CD, not playing or selected currently, to eject and exchange the CD.

If you exchange CDs during play, the current play will not stop until all CDs you have exchanged are played.

To stop play for a moment

Press CD ►/|| SELECT.

While pausing, the elapsed playing time flashes on the display.

To resume playing, press CD ►/|| SELECT.

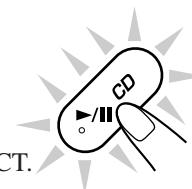

To go to another track

Turn ◀◀◀ / ▶▶▶ before or during playback (or press NEXT ▶▶▶ / ◀◀◀ PREV on the remote control).

- ◀◀◀: Goes back to the beginning of the current or previous tracks.
- ▶▶▶: Skips to the beginning of the next or succeeding tracks.

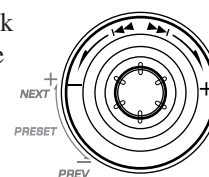

If you turn ◀◀◀ / ▶▶▶ (or press NEXT ▶▶▶ / ◀◀◀ PREV on the remote control) before playing

You can change the tracks continuously.

To locate a particular point in a track

During play, press and hold ◀◀ or ▶▶ (or NEXT ▶▶▶ / ◀◀◀ PREV on the remote control).

- ◀◀ (or ◀◀◀ PREV):
Fast reverses the disc.
- ▶▶ (or ▶▶▶ NEXT):
Fast forwards the disc.

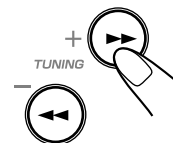

To go to another track directly using the number buttons

Pressing the number button(s) on the remote control before or during play allows you to start playing the track number you want.

Ex.: For track number 5, press 5.

For track number 15, press +10, then 5.

For track number 20, press +10, then 10.

For track number 32, press +10, +10, +10, then 2.

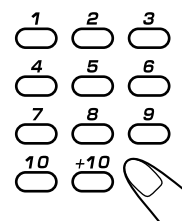

If you press the STOP button while CD/VCD is playing, the total number of tracks and the total playing time will appear on the display following by the playing time of the first track. Sometimes, during the total number of tracks appear on the display, "99" or "00" will appear for a second before actual track count comes out.

Programming the Playing Order of the Tracks — Program Play

You can arrange the order in which tracks play before you start playing. **You can program up to 50 tracks.**

- To use Repeat play (see page 17) for Program play, press REPEAT after starting Program play.
- There is a time limit in performing the following steps. If the setting is cancelled before you finish, start from step 2 again.

1 Load CDs.

- If the current playing source is not the CD player, press CD ►/|| SELECT, then ■ before going to the next step.

2 Press PROGRAM so that “PROGRAM” appears on the display.

The PRGM (program) indicator also lights up on the display.



- If a program has been stored in memory, the program is called up.

3 Press one of the disc number buttons (CD1, CD2 and CD3) to select the disc number you want to program.

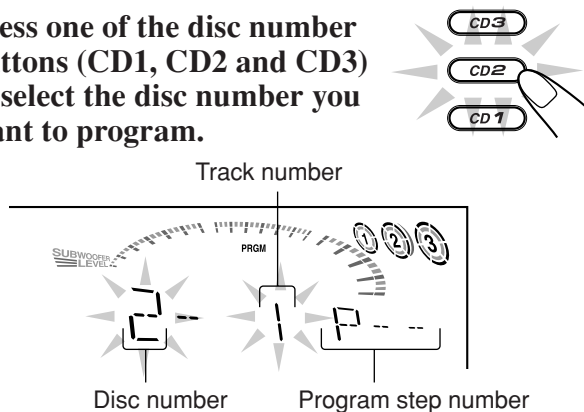

4 Select a track from the CD selected in the above step.

On the unit:

Turn ◀◀ / ▶▶ to select the track number and press SET/DISPLAY.

On the remote control:

Press the number buttons.

- For how to use the number buttons, see “To go to another track directly using the number buttons” on page 15.

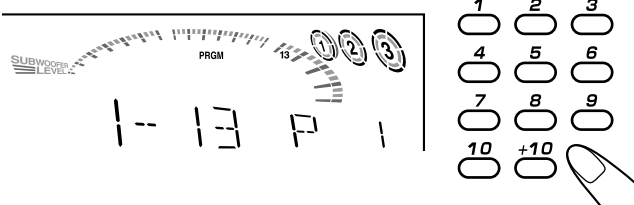

5 Program other tracks you want.

- To program tracks from the same disc, repeat step 4.
- To program tracks from a different disc, repeat steps 3 and 4.

6 Press CD ►/|| SELECT.

The tracks are played in the order you have programmed.



To stop playing, press ■.

To exit from Program play mode, press PROGRAM again before or after play. The PRGM (program) indicator goes off.



- If you try to program a 51st track “FULL” will appear on the display.
- If your entry is ignored You have tried to program a track from an empty tray, or a track number that does not exist on the CD (for example, selecting track 14 on a CD that only has 12 tracks). Such entries are ignored.
- If the total playing time is 100 minutes or more “-- : --” will appear on the display.
- If you want to eject current program play disc Press PROGRAM button to exit from program mode and program indicator disappear from the display.

To check the program contents

Before playing, you can check the program contents by pressing ►► NEXT or ◀◀ PREV on the remote control.

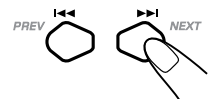

- ►► NEXT: Shows the programmed tracks in the programmed order.
- ◀◀ PREV: Shows them in the reverse order.

To modify the program

Before or after playing, you can erase the last programmed tracks by pressing CANCEL/DEMO.



- Each time you press the button, the programmed track shown on the display is erased from the program.
- Ejecting a CD will also erase the track numbers programmed from the ejected CD.

To add tracks to the program before playing, simply select the track numbers you want to add by following step 4 of the programming procedure.

To erase the entire program before or after playing, press ■. “PROGRAM” appears on the display.

The program you have made will be erased:

- when you unplug the AC power cord.
- when a power failure occurs.

Playing at Random — Random Play

The tracks of all loaded CDs will play at random.

- To use Repeat play for Random play, press REPEAT after starting Random play.

1 Load CDs.

- If the current playing source is not the CD player, press CD ►/■ SELECT, then ■ before going to the next step.

2 Press RANDOM so that “RANDOM” appears on the display.

The RANDOM indicator also lights up on the display.

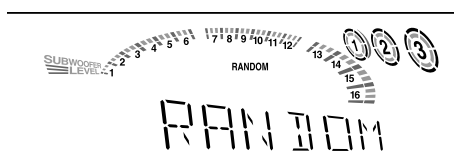

3 Press CD ►/■ SELECT.

The tracks of the current disc are randomly played until finished before changing to another tray.

Random play ends when all the tracks are played once.

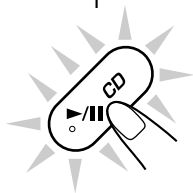

To skip the currently playing track, turn ◀◀ / ▶▶ to the right (or press ▶▶| NEXT on the remote control).



Even if you turn ◀◀ / ▶▶ to the left (or press PREV ◀◀ on the remote control)

You cannot go back to previous tracks during Random play.

To stop playing, press ■.

To exit from Random play mode, press RANDOM again before or after play.

Repeating Tracks or CDs — Repeat Play

You can have all the CDs, the program or the individual track currently playing repeat as many times as you like.

To repeat playing, press REPEAT during or before play. To use Repeat play for Program play and Random play, press the button after starting playback.

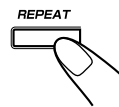

- Each time you press the button, Repeat play mode changes as indicated by the following indicator lights up on the display:

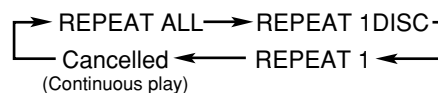

REPEAT ALL: Repeats all the tracks on all the CDs (continuously or at random) or all the tracks in the program.

REPEAT 1 DISC: Repeats all the tracks on one CD.
• REPEAT 1 DISC is not used for Program play and Random play.

REPEAT 1: Repeats one track on one CD.

To cancel Repeat play, press REPEAT repeatedly until the REPEAT indicators go off from the display.

- Repeat play is also cancelled when you select Program play or Random play.



CD repeat-all mode sometimes may not function if one or two of the trays are empty.

Prohibiting Disc Ejection — Tray Lock

You can prohibit CD ejection from the unit and lock CDs.

- This operation is possible only when the source is the CD player.

On the unit ONLY:

To prohibit disc ejection, press ▲ for any disc tray while holding down ■. (If there is any disc tray opened, close it first.)

“LOCKED” appears for a while, and the loaded CDs are locked.



To cancel the prohibition and unlock the CDs, press ▲ for any disc tray while holding down ■.

“UNLOCKED” appears for a while, and the loaded CDs are unlocked.

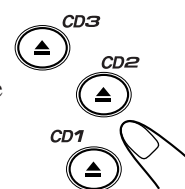

If you try to eject CDs

“LOCKED” appears to inform you that the Tray Lock is in use.

Playing Back Video CDs



Selecting Video Output (PAL, MULTI, NTSC)

You can set this setting in Standby mode.
Before playing a VCD, use the buttons on the unit to select a video output mode to match your TV system.
Video output is preset for PAL.

1 Press and hold one of the disc number buttons (CD1, CD2 or CD3) for more than 2 sec.

CD3 for NTSC exclusive TV.

CD2 for Multisystem TV.

Multi detects the formula of the disc (NTSC/PAL) automatically and displays the image on the screen correctly.

CD1 for PAL exclusive TV.

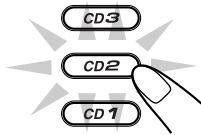

Selection of Video Output Mode

- When you play an NTSC disc in MULTI mode on a PAL exclusive TV, the image may be distorted. If this happens, change the mode to PAL.
- When you play an NTSC disc in MULTI mode on a Multisystem TV, the image may blink for a moment. This symptom is caused by the Unit detecting the formula of the disc, not by a malfunction of the unit.
- Selection of video output mode works only in standby mode.

Loading Discs

1 Press \blacktriangle for the disc tray (CD1, CD2 or CD3) you want to load a CD onto.

The unit automatically turns on and the disc tray comes out.

2 Place a disc correctly within the circle of the disc tray, with its label side up.

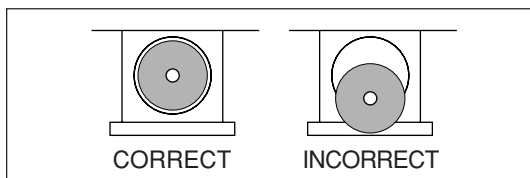

- When using a CD single (8 cm), place it within the inner circle of the disc tray.

3 Press the same \blacktriangle you have pressed in step 1.

The disc tray closes, and the corresponding disc number lamp and disc indicator light up on the display (CD1, CD2 and CD3).

4 Repeat steps 1 to 3 to place other CDs.

When you place a CD onto the currently selected tray, whose disc number shown on the CD indicator, reading of the CD starts. After the reading is completed, the total number of tracks and total playing time will appear, then the playing time of the first track.

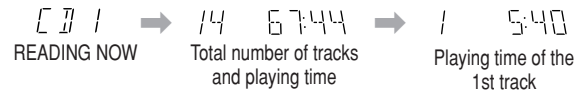

If the video CD has the Playback Control function, "VCD PBC" will appear when you press STOP followed by PBC. To put an 8 cm CD onto a tray, insert it so that it is aligned with the groove in the trays center.

If a tray is open when the System switches to the standby mode, the tray will close automatically.

Playing a Video CD

You can play video CDs either with or without the PBC function.

1 Turn on the TV and select the video input so that you can view the pictures from the CD player.

Refer to the manual supplied for your TV.

2 Prepare a CD.

Refer to "Loading Discs" on this page.

3 Start playback of the CD.

Press CD \blacktriangleright /|| SELECT, to start playback of the currently selected CD, or press CD 1-3, to select the disc and start play.

Compu Play

When CD \blacktriangleright /|| SELECT, or CD 1-3, is pressed while the system is on standby, the power is automatically turned on.

To stop during play, press \blacksquare .

To stop play and remove the disc, press \blacktriangle for the disc being played.

Playing Video CDs with PBC Function — Menu Play

This System provides Playback Control (PBC) which utilizes a procedure (menu selection) programmed in a video CD. The playback operation procedure may differ depending on the disc you use.

For Menu Play, use the following buttons:

On the unit:

- NEXT** (▶▶) for viewing the unshown portion of the menu
- PREV** (◀◀) for viewing the previously shown portion of the menu
- CD ▶/|| SELECT** for starting playback of the selected item
- ↶ RETURN** for going back to the previous menu
- VCD NUMBER +, -** for selecting an item

On the remote control:

- ▶▶ (NEXT)** for viewing the unshown portion of the menu
- ◀◀ (PREV)** for viewing the previously shown portion of the menu
- NUMBER BUTTONS** ... for selecting and starting playback of an item
- (CD ▶/||) SELECT** for starting playback of the selected item
- ↶ RETURN** for going back to the previous menu

Basic Concept of the PBC function

PBC (Playback Control) allows you to enjoy menu-driven operation and high resolution still images having a resolution four times greater than video pictures.

Menu-driven playback

You can interact with the screen using a menu display to select and play an entry.

1 Turn on the TV and select the video input so that you can view the pictures from the CD Player.
Refer to the manual supplied for your TV.

2 Prepare a CD.

Refer to “Loading Discs” on page 18.

3 Press PBC on the unit.

Allow several seconds for the disc's table of contents (TOC) to be read before pressing PBC. “VCD PBC” appears on the display.

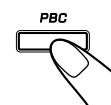

4 Start playback of the CD.

Press CD ▶/|| SELECT, to start play of the currently selected CD, or press CD 1-3, to select the disc and start play.

5 Select the item you want to view.

On the unit:

Turn VCD NUMBER + to select larger item numbers, or turn VCD NUMBER – to select smaller item number. Then press CD ▶/|| SELECT, to start the disc. In case VCD number cannot be selected from the unit, please use the remote control.

On the remote control:

Press the number buttons to select and play the item you want.

To stop the track being played and return to the menu, press ↶ RETURN button.

To stop Menu Play, press ■.

NOTE:

You can only select PBC in CD STOP and repeat off position.

High-resolution still image display

You can display high-quality images four times clearer than video pictures.

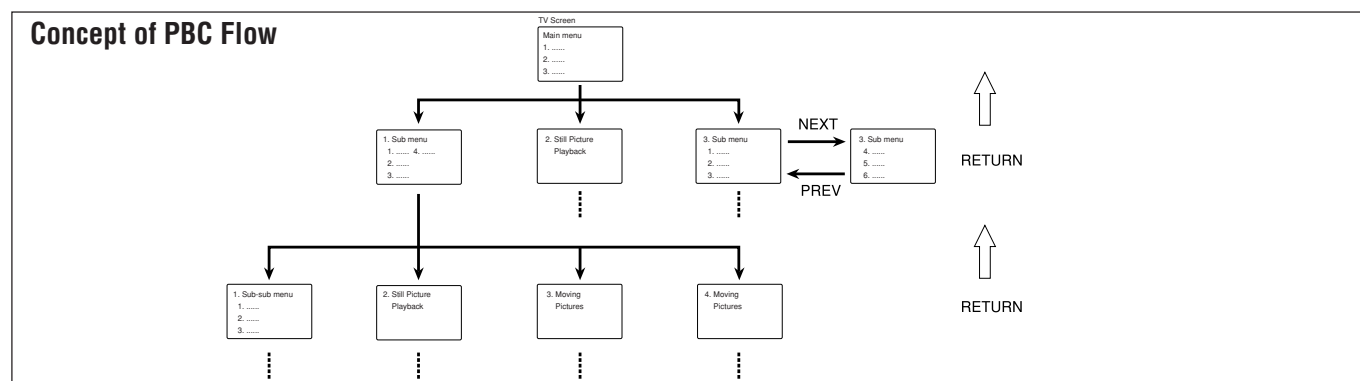

Basic flow of Menu Play Operation

A selection menu is shown when you start playing a video CD with PBC. The menu shows a list of items to select. Some discs may show moving pictures or a divided screen.

- When a list of items appears, you can select the number of the item you want to playback.
- When moving pictures appear, you can select a moving picture by pressing ◀◀ PREV / ▶▶ NEXT or number buttons while the moving picture you want to view is being played back.

- When the menu appears after the item you have selected finishes playing, you can select another item that you want to view next.
- After playback, press ↶ RETURN, to go back to the previous screen. Each time you press the button, you will go back by one screen.
- If you want to stop Menu Play, press ■.

**Screen-saver**

- When a menu screen of a karaoke disc is displayed for a few minutes without any selection being made, it automatically starts from the first song.

Reminder!

Do not pause Video CD for more than 10 minutes to prevent screen burns.

Playing Video CDs without PBC — Continuous Play

Even if a video CD has PBC, you can cancel PBC and play the disc without using the menu screen.

1 Turn on the TV and select the video input so that you can view the pictures from the CD Player.

Refer to the manual supplied for your TV.

2 Prepare a CD.

Refer to “Loading Discs” on page 18.

3 Start playback of the CD.

On the unit:

Press CD ►/|| SELECT or CD 1-3 of the tray you want to play from. The selected video CD starts playback from the first track.

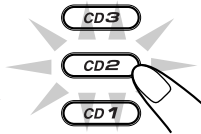
**On the remote control:**

Press the number button of the track you want to start playing. The playback starts from the selected track of the currently selected disc.

To stop during play, press ■.

To restore PBC, press the PBC button again, then press current CD1, CD2 or CD3 to play VCD with PBC.

**Cancelling PBC**

- After cancelling PBC, you can Continuously Play more than one video CD without PBC.
- When PBC is cancelled, some images such as still play pictures may not be played back.
- You cannot change from PBC OFF to PBC ON while CD is playing.

Reminder!

Disconnect your CD OPTICAL DIGITAL OUTPUT when playing or recording a Video CD.

Resuming Play

If you stop a video CD directly, you can continue viewing from the scene where you last stopped.

1 During playing of a VCD, press ■ button to stop playing (refer to page 18).

2 Press CD ►/|| SELECT button to continue playback from the last scene that you stopped at.

NOTE:

- 1 Resume play will not work when the CD tray has been opened.
- 2 It is advisable to turn off PBC to use resume play otherwise it will resume at PBC menu.
- 3 Resume Play will not function on VCD version 1.1.

Special Plays for a Video CD

You can use the following special play modes for video CDs both with and without PBC. The following functions can only be executed with the buttons on the remote control.

Frame-by-Frame Playback

Press the STILL button during playback. Then each time you press the button, still pictures advance by one frame. During frame-by-frame playback, no sound is emitted.



To resume normal playback, press CD ►/|| SELECT.

Viewing Operating Status

Usually, the following information of the track being played is shown on the TV screen during playback : the disc number, the track number, and the playing time.

Press ON SCREEN.

This button toggles the display of operation status. When the display of operation status turns on, the following information of the track being played appear on the TV screen: Disc number, track number / total number of tracks and the current tracks elapsed time.

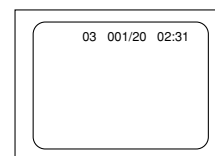
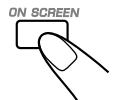

To cancel the display of operation status, press ON SCREEN.

Viewing the Video Intro of the Video CD

You can view the contents of a video CD, watching for about 7 seconds of each track on the video CD. Video intro does not work with PBC. For a video CD with PBC, cancel the PBC function referring to “Playing Video CDs without PBC” above.

1 Press CD 1-3, to select the disc you want to view the video intro. Playback starts.

2 Press V.INTRO on the remote control after a picture appears on the TV screen.

The video intro play starts and shows in sequence for about 7 seconds of the first nine tracks on the TV screen. To preview subsequent tracks, press “▶▶ NEXT” on the remote control. Pressing “PREV ◀◀” will display the previous 9 track intros.

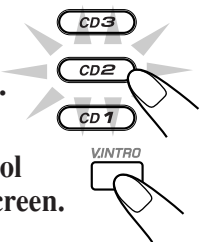

The TV screen will show the following:

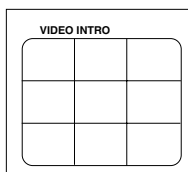

3 Press the number button for the video intro you want to select.

Playback starts from the selected track.

To stop and cancel the video intro play, press ■.

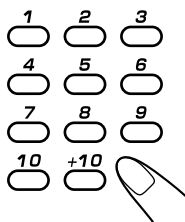

Viewing the Highlights of a Video CD

You can view highlight scenes of the selected track on a video CD only when PBC is off. These highlight scenes are created by dividing the track equally into 9 portions and the beginning scenes (5 seconds each) of those 9 portions are shown on the display.

1 Press CD 1-3, and the number button for the track you want to view the highlights of.

Playback starts.

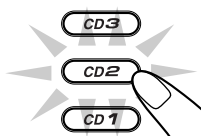

2 Press HIGHLIGHT on the Remote after a picture appears on the TV screen.

The highlight play starts and shows in sequence, the first 5 seconds of nine track divisions on the TV screen for 1 minute. To preview subsequent tracks, press "▶▶ NEXT" on the remote control. If a highlight scene is not selected, it will automatically stop after a few minutes.



TV screen will show the following:

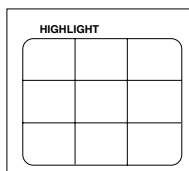

3 Press the number button for the highlight you want to select.

Playback starts from the selected scene.

To stop and cancel the highlight play, press ■.

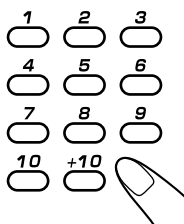

Viewing highlights

- If a highlight scene is not selected while 9 scenes are shown on the TV, highlight scenes of the next track will appear on the display.
- When a highlight scene is selected, playback starts from the beginning of the highlight scene, but not from the still image shown on the display (the part shown is the last part of the highlight scene, not its beginning)
- During the video intro or highlight play, images shown on the display may be partially distorted, resulting from noise or incorrect manufacturing of the disc.
- Highlight also can function in stop position.

Playing a Multiplex Sound CD

This function is used for multiplex sound discs. See manuals attached to discs for detailed information.

Operation

By pressing the MPX button on the remote control consecutively, channel multiplexing modes are cycled as shown below.

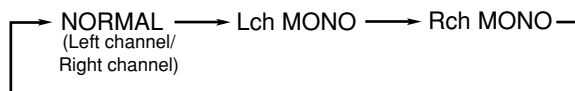
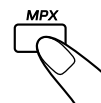

When Lch MONO or Rch MONO is selected, display indicates Lch MONO or Rch MONO respectively.

Lch MONO: Only the left channel (instrumental parts) is played back through both right and left speakers.

Rch MONO: Only the right channel (vocal parts) is played back through both right and left speakers.

NORMAL: Used for conventional stereo sources.

MP3 Disc Playback

About MP3 discs

An MP3 disc can have several folders (albums). Tracks are contained within the albums. The player will only recognize up to 64 albums. Total number of tracks recognizable is 255.

Recording your own MP3 discs

- Disc format should be set to “ISO 9660”.
- Multisession recording is not supported.
- The disc must be finalized.
- Files other than MP3 will be ignored.

Unavailable functions

- Program recording and random recording to cassette tape.

Basic operations

If your TV set is connected to the unit, you can view the contents of the MP3 disc on-screen.

1 Insert an MP3 disc.

2 Press CD1, CD2 or CD3.

The following display will appear on the TV screen. (It may take some time for the display to appear depending on the disc being played.)

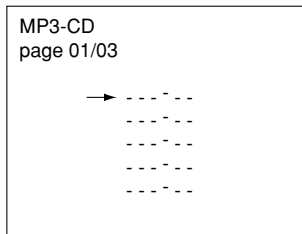

3 Turn PRESET +/- NEXT/PREV (press ◀◀◀ PREV or ▶▶▶ NEXT on the remote control) to select the album. At the last entry, turn + NEXT will move to the next page (if any). Albums are arranged in alphabetical order.

4 Press CD ▶/|| SELECT to confirm your album selection.

The following display will appear on the TV screen.

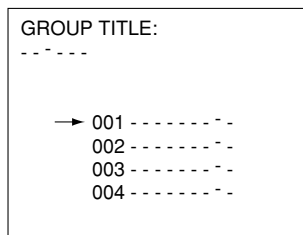

5 Turn PRESET +/- NEXT/PREV (press ◀◀◀ PREV or ▶▶▶ NEXT on the remote control) to select the track.

6 Press CD ▶/|| SELECT to play.

The next track will be automatically played after the current track is finished.

7 If you press and hold ◀◀◀ or ▶▶▶ (press ◀◀◀ PREV or ▶▶▶ NEXT on the remote control), you can fast search (reverse/forward) within a track. The track elapsed time on the unit's display will change.

8 Press ■ to stop playing. Press ■ again for album menu.

NOTE:

At any time you may select a track from any album by pressing the number keys on the remote control.

Example:

For track number 28, press +10 twice, then 8.

Programming tracks

1 Press PROGRAM on the unit. The following screen will appear on your TV.

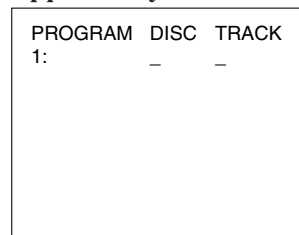

2 Select an MP3 disc using the CD1, CD2 or CD3 button.

3 Select a track using PRESET +/- NEXT/PREV (the number buttons on the remote control). Then press SET/DISPLAY button. You cannot select an album.

- The next program will appear on the screen in order of the entry.
- To cancel the entry, press CANCEL/DEMO.
- To cancel the whole program, press PROGRAM again.

4 Press CD ▶/|| SELECT to start program playback.

- To stop playing, press ■.
- To skip program, turn PRESET +/- NEXT/PREV (press ◀◀◀ PREV or ▶▶▶ NEXT on the remote control).
- To cancel the program, press ■ while the disc is not playing.

Other special functions

- To select the intended repeat play mode, press REPEAT button. Each time you press the button, Repeat play mode changes as follows:
Repeat All → Repeat 1 disc → Repeat 1 track → Cancelled (back to the beginning)
- To select the random play mode, press RANDOM button then press CD ▶/|| SELECT.
The tracks are played at random.
To cancel the random play, press ■.
- Press ON SCREEN button on the remote control. The following information will appear on your TV unit:
“disc number of track”, “total number of tracks”, “track elapsed time”.
- To mask the lead vocal, press KARAOKE button on the remote control.

Playing Back Tapes



You can playback type I, type II and type IV tapes without changing any settings.

Playing Back a Tape

- 1** Press EJECT (▲) for the deck you want to use.

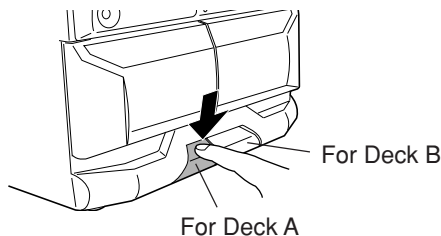

- 2** Put a cassette in with the exposed part of the tape down.

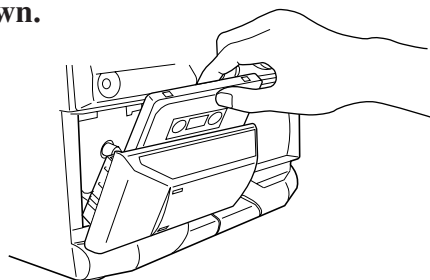

- 3** Close the cassette holder gently.

If you put cassettes in both decks A and B, the last deck you have put a cassette into is selected.

To select the other deck, press TAPE A/B.

- 4** Press TAPE ◀▶.

The tape play starts and the tape direction indicator (▶ or ◀) starts flashing slowly to indicate the tape running direction.

- Each time you press the button, the tape direction changes.
 - ▶ : plays the front side.
 - ◀ : plays the reverse side.
- If no cassette is inserted, “NO TAPE” appears on the display.

When the tape plays to the end, the deck automatically stops if the Reverse Mode is off. (See “To play both sides repeatedly — Reverse Mode.”)

To stop playing, press ■.

To operate the other deck, press TAPE A/B, then TAPE ◀▶.

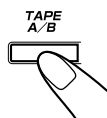

To fast-wind to the left or to the right, press ◀◀ or ▶▶ (◀◀ PREV or ▶▶ NEXT on the remote control) while the tape is not running.

The tape direction indicator (▶ or ◀) starts flashing quickly on the display.

To remove the cassette, press ▲ EJECT for deck A or EJECT ▲ for deck B.

To play both sides repeatedly — Reverse Mode

Reverse Mode works for both decks at the same time.

When it is in use, the tape automatically reverses at the end of a side and the unit starts playing the other side of the tape, and repeats the same process.

To use Reverse Mode, press REVERSE MODE so that the Reverse Mode indicator on the display lights up — (↔).

To cancel Reverse Mode, press the button again so that the Reverse Mode indicator on the display lights up — ↔.

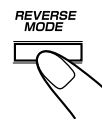

When Reverse Mode is on with cassettes in both decks A and B

After the reverse (◀) side of the tape finishes playing, the tape in the other deck starts playing.

Locating the Beginning of a Song — Music Scan

You can use Music Scan to locate the beginning of a song. Music Scan searches for blank portions that usually separate recorded songs, then plays the next song.

To find the beginning of the current song

During play, press ◀◀ or ▶▶ (◀◀ PREV or ▶▶ NEXT on the remote control) in the opposite direction to the tape play.

The tape direction indicator of the opposite direction to the tape play starts flashing slowly.

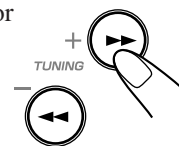

Searching stops automatically at the beginning of the current song, and the current song starts automatically.

To find the beginning of the next song

During play, press ◀◀ or ▶▶ (◀◀ PREV or ▶▶ NEXT on the remote control) in the same direction as the tape play.

The tape direction indicator of the same direction as the tape play starts flashing slowly and quickly alternately.

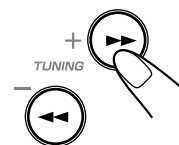

Searching stops automatically at the beginning of the next song, and the next song starts automatically.



Music Scan works by detecting a 4-second long blank between each song, so it will not work well in the following cases

- No blank at the beginning of a song.
- Noise (often caused by much use or poor quality dubbing) which fills the blank.
- Long, very soft passages or pauses in a song.



The use of the C-120 or thinner tape is not recommended, since characteristic deterioration may occur and this tape easily jams in the pinch-rollers and the capstans.

Recording



IMPORTANT:

- It may be unlawful to record or play back copyrighted material without the consent of the copyright owner.
- The recording level is automatically set correctly, so it is not affected by the VOLUME, the SUBWOOFER LEVEL, and the SOUND MODE controls. Thus, during recording you can adjust the sound you are actually listening to without affecting the recording level.
- If recordings you have made have excessive noise or static, the unit may be too close to a TV. Increase the distance between the TV and the unit.
- You can use type I tape for recording.

To protect your recording

Cassettes have two small tabs on the back to protect from accidental erasure or re-recording.

To protect your recording, remove these tabs.

To re-record on a protected tape, cover the holes with adhesive tape.

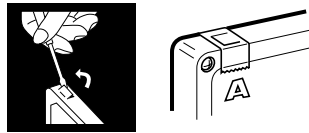

To keep the best recording and playback sound quality

If the heads, capstans, and pinch rollers of the cassette decks become dirty, the following will occur:

- Impaired sound quality
- Discontinuous sound
- Fading
- Incomplete erasure
- Difficulty in recording

To clean the heads, capstans, and pinch rollers

Use a cotton swab moistened with alcohol.

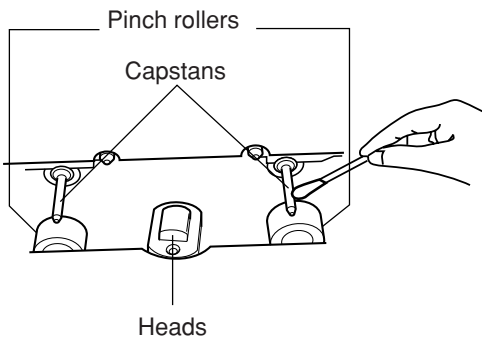

To demagnetize the heads

Turn off the unit, and use a head demagnetizer (available at electronics and audio shops).

Recording a Tape on Deck B

1 Press EJECT ▲ for deck B.

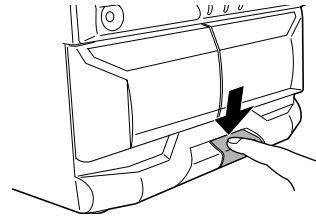

2 Put a recordable cassette into deck B.

3 Close the cassette holder gently.

4 Check the tape direction of deck B.

- If the tape direction is not correct, press TAPE ◀▶ twice then ■ to change the tape direction.

5 Start playing the source — FM, AM, CD player, deck A or auxiliary equipment connected to AUX jacks.

- When the source is CD, you can also use CD Direct Recording (see page 25) and Auto Edit Recording (see page 26).
- When the source is deck A, you can also use the dubbing method. (See “Dubbing Tapes” on page 25.)

6 Start recording.

On the unit ONLY:

Press REC START/STOP.

The **REC** (recording) indicator lights up on the display and recording starts.

- If no cassette is inserted, “NO TAPE” appears on the display. If a protected tape is inserted, “NO REC” appears on the display.



To stop recording immediately, press ■.

To remove the cassette, press EJECT ▲ for deck B.

To record on both sides — Reverse Mode

Press REVERSE MODE so that the Reverse Mode indicator lights up — .

- When using Reverse Mode for recording, start recording in the forward (▶) direction first. Otherwise, recording will stop when recording is done only on one side (reverse) of the tape.

To cancel Reverse Mode, press the button again so that the Reverse Mode indicator lights up — .

Dubbing Tapes

You can record from one tape to another.

On the unit ONLY:

- 1 Press TAPE ◀▶, then ■.

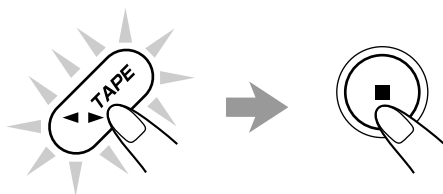

- 2 Put the source cassette into deck A, and a recordable cassette into deck B.

- Put the cassettes in both decks so that the tapes will run in the forward (▶) direction.

- 3 Press DUBBING.

The **REC** (recording) indicator lights up on the display and dubbing starts.



To stop dubbing, press ■ so that both decks (A and B) stop.

To record on both sides — Reverse Mode

Press REVERSE MODE so that the Reverse Mode indicator lights up — .

To cancel Reverse Mode, press the button again so that the Reverse Mode indicator lights up — .

**CD Direct Recording**

Everything on the CD goes onto the tape in the order played out on the CD.

On the unit ONLY:

- 1 Put a recordable cassette into deck B.

- 2 Load CDs.

- 3 Press one of the disc number buttons (CD1, CD2 and CD3) to select the disc, then ■.



- 4 Press CD REC START.

“CD REC” appears, and the **REC** (recording) indicator lights up on the display.

Deck B starts recording and the CD player starts playing. When the recording is done, “CD REC FINISHED” appears on the display and deck B stop. CD player will continue play for the next tray until you press STOP button.



To stop recording, press REC START/STOP or ■. So that a 4-second blank portion is created on the recording tape. (Remember a 4-second blank is important when using Music Scan — see page 23.)



- You cannot use CD Direct Recording to record a Program Play.
- Before recording on a tape, wind the tape on past the leader tape (about the first 3 or 4 seconds of each side).

To record on both sides — Reverse Mode

Press REVERSE MODE so that the Reverse Mode indicator lights up like — .

- When using the Reverse Mode for CD Direct Recording, start recording in the forward (▶) direction first. When the tape reaches its end while recording a song in the forward direction (▶), the last song will be re-recorded at the beginning of the reverse side (◀). If you start recording on the reverse side (◀), recording will stop when recording is done only on one side (reverse) of the tape.

To cancel Reverse Mode, press the button again so that the Reverse Mode indicator lights up — .

Auto Edit Recording

By using Auto Edit Recording, you can record the CD tracks to fit the tape. Auto Edit Recording makes a program by selecting the CD tracks in numerical order. However, to prevent the end of the last track on the front side from being cut off, the last track is selected so as to fit on the remaining tape length.

On the unit ONLY:

1 Load CDs.

- If the current playing source is not the CD player, press CD ►/|| SELECT or CD 1-3 of the tray you want to edit from, then ■ before going to the next step.

2 Press EDIT.

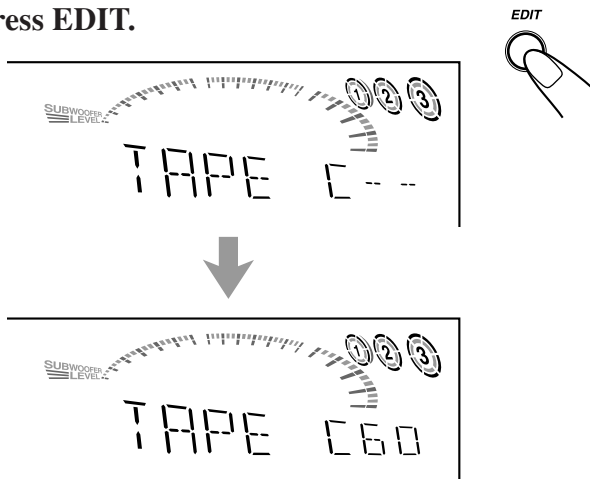

The optimum tape length for the disc appears.

To change the tape length manually

If the tape length selected is not satisfactory, you can change the tape length by turning ◀◀ / ▶▶ on the unit. You can choose from the following tape lengths — 40, 46, 50, 54, 60, 64, 70, 74, 80, 84 and 90.

3 Press SET/DISPLAY.

- Each time you press the button, the tracks to be recorded on the front side (“SIDE-A”) and on the reverse side (“SIDE-B”) alternate.

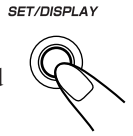

Tracks to be recorded on the reverse side (SIDE-B) appear.

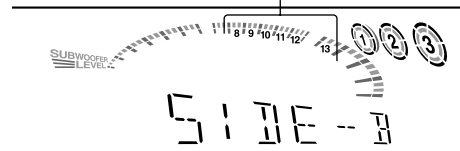

4 Put a recordable cassette of appropriate length into deck B.

5 Press REVERSE MODE so that the Reverse Mode indicator lights up (↔).

- Without turning on the Reverse Mode (↔), recording will stop when the front side of the tape is recorded.

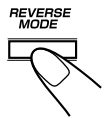

6 Press CD REC START.

“TAPE SIDE-A STAND-BY” appears, and the **REC** (recording) indicator lights up on the display.

Deck B starts recording then, about 10 seconds later, the CD player starts playing.

When the recording is done, “CD REC FINISHED” appears on the display, and the CD player and deck B stop.

- If a tape has not been rewound, deck B will rewind the tape before it starts recording.
- A 10-second blank portion is automatically created at the beginning of each side of the tape.



To stop during Auto Edit Recording

Press REC START/STOP or ■. So that a 4-second blank portion is created on the recording tape. (Remember a 4-second blank is important when using Music Scan — see page 23.)

To cancel Auto Edit Recording

Press CANCEL/DEMO or ■ before or after play.

Using the Microphones



You can enjoy singing along (Karaoke) and microphone mixing using two microphones.

- MIC LEVEL adjustment is valid for both microphones connected MIC 1 and MIC 2 jacks.

IMPORTANT:

- Always set MIC LEVEL to MIN when connecting or disconnecting the microphone.
- When not use the microphones, keep them disconnecting.

Singing along — Karaoke

Vocal Masking

Vocal Masking reduces the lead vocal of the playing source, and allows you to replace it by singing into the microphones as the music plays.

1 Turn MIC LEVEL to MIN.

2 Connect the microphone(s) (not supplied) by plugging it into MIC 1 and/or MIC 2 jack.

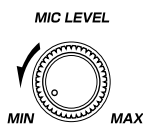

3 Press KARAOKE on the remote control.

The karaoke (🎤) indicator lights up on the display.



4 Start playing the source — CD, tape or other connected component.

5 Turn MIC LEVEL and VOLUME as you sing into the microphone(s).

- By pressing REC START/STOP, you can record your singing along if you want. (For more details, see page 25.)

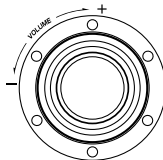

To apply an echo to your voice

Press ECHO on the remote control so that the echo (🔊) indicator lights up on the display.

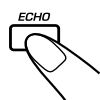
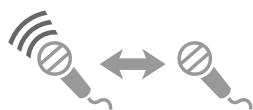

Each time you press the button, the echo level changes as follows:

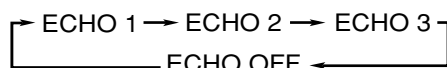

- As the number increases, a stronger echo effect is applied to your voice.



If howling or squealing (feedback) occurs while using the microphone(s)

Take the following actions to prevent these noises.

- Adjust MIC LEVEL and VOLUME.
- Avoid pointing the microphone(s) towards the speakers.
- When two microphones are connected, turn off the ON/OFF switch on the unused microphone.



If you use the following sources as the playing source for Karaoke (Vocal Masking), you cannot get the satisfactory results

- Radio programs — a radio signal is not as reliable as the signals coming from a tape or CD.
- Monaural sources.
- Poorly dubbed tapes.
- Sources recorded with duets, strong echo, a chorus or only a few instruments.

Singing Along with Multiplex Karaoke Discs (MPX)

If the source you are going to play is a multiplex karaoke disc, you can use the Multiplex sound function via the buttons on the unit.

What is Multiplex Sound?

On a multiplex karaoke disc, the instrumental parts are recorded on the left channel. With this system, you can replace the vocal part with your voice through the microphone.

1 Rotate the MIC LEVEL and VOLUME to MIN.

2 Connect the microphone (not supplied) into the MIC 1 and/or MIC 2 jack on the front panel.

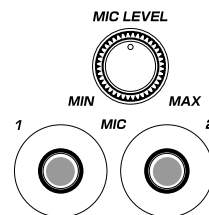

3 Play the source — CD.

4 Press MPX on the remote control to select the output sound. Please refer to page 21.



5 Turn MIC LEVEL and VOLUME to adjust the microphone level and the speaker output level.

6 Sing into the microphone.

To apply echo to your voice, see “To apply an echo to your voice” on this page.

To adjust the music key, see “Adjusting the Music Key Control” on page 28.

To record your singing along, see “Microphone Mixing” on page 25.



When finished singing

Restore the stereo effect by pressing MPX until “NORMAL” appears on the display.

Recording Your Singing

You can adjust the music key using the remote control.

- 1 Follow the steps in “Singing Along with Multiplex Karaoke Discs (MPX)” in page 27.
- 2 Follow the steps in “Recording a Tape on Deck B” on page 24 to record your singing.

Adjust the Music Key Control (for CD play only)

On the remote control ONLY:

- 1 Press **KEY CONTROL b/#** to adjust the music key.

To lower the key, press **KEY CONTROL b**.

To raise the key, press **KEY CONTROL #**.

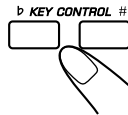

To cancel the key adjustment, press **KEY CONTROL b** or **#** until “KEY 0” appears on the display



Adjust the music key each time you sing along to a song

Once the music key is adjusted, the key level will not return to the previous level automatically after playing a song.

The music key cannot be changed while recording.

Once the source is changed, the key level returns to 0.

The Sound Mode will be cancelled if the Multiplex sound is selected.

Microphone mixing

When you sing along with multiplex tapes or CDs, follow the procedure below:

- 1 Connect the microphone(s).
- 2 Start playing the source — CD, tape or other connected component.
- 3 Turn **MIC LEVEL** and **VOLUME** as you sing into the microphone(s).
 - By pressing REC START/STOP, you can record your singing along if you want. (For more details, see page 25.)

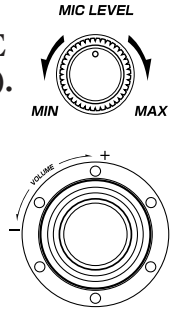

To use microphone only

Without any background sound, you can use your microphone(s) and record it if you want.

- 1 Connect the microphone(s).
- 2 Press **CD ►/|| SELECT**, then **■**.
No background sound will be heard.

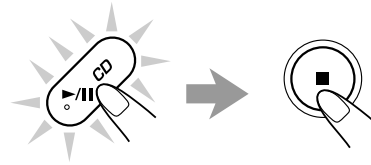

- 3 Turn **MIC LEVEL** and **VOLUME** as you sing into the microphone(s).
 - By pressing REC START/STOP, you can record your singing along if you want. (For more details, see page 25.)

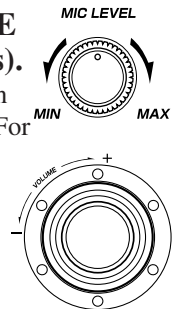

Using the Timers



There are three timers available — Daily Timer, Recording Timer and Sleep Timer.

Before using the timers, you need to set the clock built in the unit. (See page 10.)

Using Daily Timer

With Daily Timer, you can wake to your favorite music or radio program. You can set the timer whether the unit is on or off.

How Daily Timer works

The unit automatically turns on, sets the volume level to the preset level, and starts playing the specified source when the on-time comes (the ☺ indicator flashes just before the on-time, and continues flashing while the timer is operating).

Then, when the off-time comes (“OFF” flashes just before the off-time), the unit automatically turns off (on standby).

The Daily timer works everyday automatically. If you do not want to use the Daily timer, turn off the Daily timer. (See “To turn on or off Daily Timer after its setting is done” on page 30.) The timer setting remains in memory until you change it.

- There is a time limit in performing the following steps. If the setting is cancelled before you finish, start from step 1 again.
- To correct a mis-entry while setting the timer, press CANCEL/DEMO.

Before you start...

- *When using a CD as the source to play —*
 - Make sure there is a CD on the selected disc number tray.
- *When using a tape as the source to play —*
 - Make sure that a tape is in the deck whose deck indicator (A or B) is lit on the display.
 - Make sure that the tape direction is correct.
- *When using an external component as the source to play —*
 - Set the timer equipped on the external component at the same time.

On the unit ONLY:

- 1 Press **CLOCK/TIMER** repeatedly until “DAILY” appears on the display.

☺ indicator lights up and DAILY (Daily Timer) indicator also starts flashing on the display.

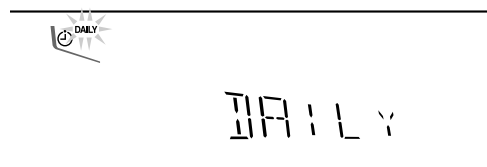

- Each time you press the button, the timer setting modes change as follows:

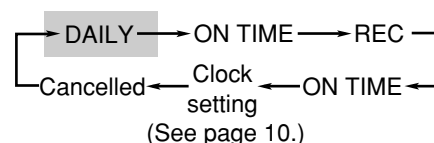

- 2 Press **CLOCK/TIMER** again.

“ON TIME” appears for 2 seconds, then the unit enters on-time setting mode.



- 3 Set the on-time you want the unit to turn on at.

- 1) Turn **◀▶** to set the hour, then press **SET/DISPLAY**.
- 2) Turn **◀▶** to set the minute, then press **SET/DISPLAY**.

“OFF TIME” appears for 2 seconds on the display, then the unit enters off-time setting mode.

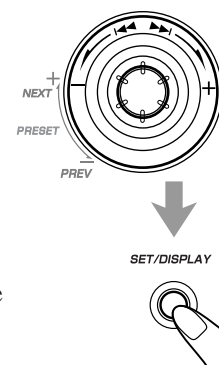

- 4 Set the off-time you want the unit to turn off (on standby) at.

- 1) Turn **◀▶** to set the hour, then press **SET/DISPLAY**.
- 2) Turn **◀▶** to set the minute, then press **SET/DISPLAY**.

The unit enters source selecting mode.

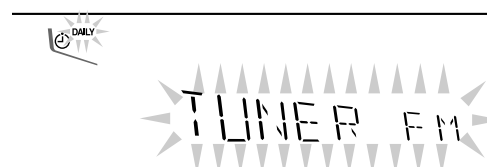

5 Turn to select the source to play, then press SET/DISPLAY.

- The source changes as follows:

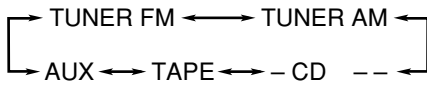

TUNER FM: tunes into a specified preset FM station.

→ Go to step 6.

TUNER AM: tunes into a specified preset AM station.

→ Go to step 6.



- CD - -: plays a disc from a specified track of a specified disc. → Go to step 6.

TAPE: plays a tape in deck A or B.

→ Go to step 7.



AUX: plays an external source. → Go to step 7.



6 When selecting “TUNER FM” or “TUNER AM”

Turn   to select the preset station number, then press SET/DISPLAY.

The unit enters volume setting mode.

When selecting “- CD - -”

1) Turn   to select the disc number, then press SET/DISPLAY.

2) Turn   to set the track number, then press SET/DISPLAY.

The unit enters volume setting mode.

7 Turn to set the volume level.

- The volume level changes as follows:

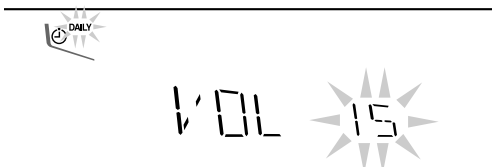
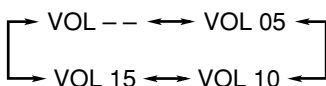

- If you select “VOL --,” the volume is set to the last level when the unit has been turned off.

8 Press SET/DISPLAY to complete the Daily Timer setting.

The DAILY (Daily Timer) indicator stops flashing and remains lit. The settings you have done are shown on the display in sequence.

SET/DISPLAY



9 Press STANDBY/ON to turn off the unit (on standby) if you have set the Daily Timer with the unit turned on.

STANDBY/ON



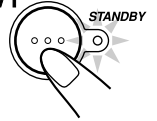

- If the unit is turned on when the on-time comes Daily Timer does not work.
- Even if you unplug the AC power cord or if a power failure occurs

Once you set the timer, the timer setting may remain stored in memory in a few days. In this case, check whether the timer setting still remains or not.

To turn on or off Daily Timer after its setting is done

1 Press CLOCK/TIMER repeatedly until “DAILY” appears on the display.



2 To turn off the Daily Timer, press CANCEL/DEMO.

 indicator and the DAILY (Daily Timer) indicator go off from the display (“OFF” appears for a while).

The Daily Timer is cancelled, but the setting for the Daily Timer remains in memory.



To turn on the Daily Timer, press SET/DISPLAY.

 indicator and the DAILY (Daily Timer) indicator light up on the display. The settings you have done are shown on the display in sequence for your confirmation.

SET/DISPLAY



Using Recording Timer

With Recording Timer, you can make a tape of a radio broadcast automatically. You can set the timer whether the system is on or off.

How Recording Timer works

The unit automatically turns on, tunes into the specified station, sets the volume level to “VOL MIN,” and starts recording when the on-time comes (the  indicator flashes just before the on-time, and continues flashing while the timer is operating). Then, when the off-time comes (“OFF” appears just before the off-time), the unit automatically turns off (on standby).

The timer setting remains in memory until you change it.

- There is a time limit in doing the following steps. If the setting is cancelled before you finish, start from step 1 again.
- To correct a mis-entry while setting the timer, press CANCEL/DEMO.

On the unit ONLY:

1 Put a recordable cassette into deck B.

2 Press CLOCK/TIMER repeatedly until “REC” appears on the display.



The REC (Recording Timer) indicator also starts flashing on the display.

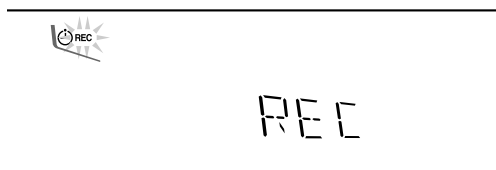

- Each time you press the button, the timer setting modes change as follows:

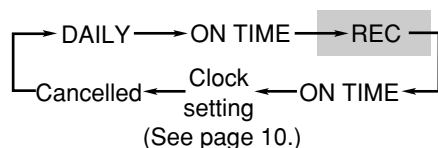





3 Press CLOCK/TIMER again.

“ON TIME” appears for 2 seconds, then the unit enters on-time setting mode.





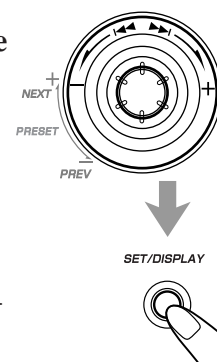

4 Set the on-time you want the unit to turn on at.





- 1) Turn   to set the hour, then press SET/DISPLAY.
 - 2) Turn   to set the minute, then press SET/DISPLAY.
- “OFF TIME” appears for 2 seconds, then the unit enters off-time setting mode.



5 Set the off-time you want the unit to turn off (on standby) at.

- 1) Turn   to set the hour, then press SET/DISPLAY.
 - 2) Turn   to set the minute, then press SET/DISPLAY.
- The unit enters preset station selecting mode.

6 Select the preset station.

- 1) Turn   to select the band (“TUNER FM” or “TUNER AM”), then press SET/DISPLAY.
 - 2) Turn   to select a preset channel number, then press SET/DISPLAY.
- The REC (Recording Timer) indicator stops flashing and remains lit. The settings you have done are shown on the display in sequence.

7 Press STANDBY/ON to turn off the unit (on standby) if necessary.

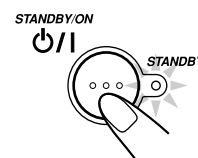

- **If you want to listen to another source while recording**
Press REC START/STOP or  to stop recording. Without stopping it, you cannot change the source.
- **Even if you unplug the AC power cord or if a power failure occurs**

Once you set the timer, the timer setting may remain stored in memory in a few days. In this case, check whether the timer setting still remains or not.

To turn on or off Recording Timer after its setting is done

1 Press **CLOCK/TIMER** repeatedly until **“REC”** appears on the display.

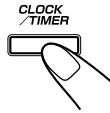

2 To turn off the Recording Timer, press **CANCEL/DEMO**.

The REC (Recording Timer) indicator goes off from the display.

The Recording Timer is cancelled, but the setting for the Recording Timer remains in memory.

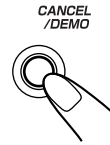

To turn on the Recording Timer, press **SET/DISPLAY**.

The REC (Recording Timer) indicator lights up on the display. The settings you have done are shown on the display in sequence for your confirmation.



Using Sleep Timer

With Sleep Timer, you can fall asleep to music. You can set Sleep Timer only while the unit is turned on.

How Sleep Timer actually works

The unit automatically turns off after the specified time length passes.

On the remote control ONLY:

1 Press **SLEEP**.

The time length until the shut-off time appears and the SLEEP indicator starts flashing on the display.

- Each time you press the button, the time length changes as follows:

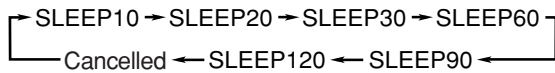

2 Wait for about 5 seconds after specifying the time length.

The SLEEP indicator stops flashing and remains lit.

To check the remaining time until the shut-off time, press SLEEP once so that the remaining time until the shut-off time appears for about 5 seconds.

To change the shut-off time, press SLEEP repeatedly until the desired time length appears on the display.

To cancel the setting, press SLEEP repeatedly so that the SLEEP indicator goes off.

- Sleep Timer is also cancelled when you turn off the unit.

Timer Priority

Since each timer can be set separately, you may wonder what happens if the settings for these timers overlap. Here are examples.

Recording Timer has priority over Daily Timer and Sleep Timer.

- If Daily Timer is set to come on while Recording Timer is operating, Daily Timer will not come on at all.

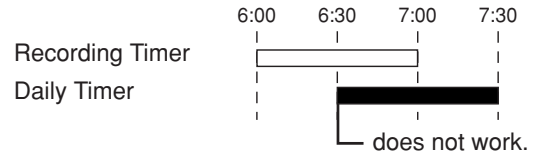

- If Recording Timer is set to come on while Sleep Timer is operating, Sleep Timer will not work (the SLEEP indicator does not go off).

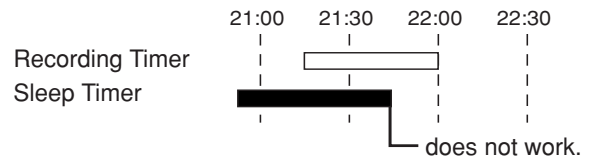

Maintenance



To get the best performance of the unit, keep your discs, tapes, and mechanism clean.

Handling discs



- Remove the disc from its case by holding it at the edge while pressing the center hole lightly.
- Do not touch the shiny surface of the disc, or bend the disc.
- Put the disc back in its case after use to prevent warping.

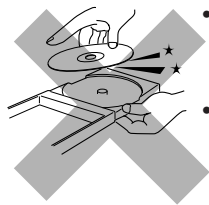

- Be careful not to scratch the surface of the disc when placing it back in its case.
- Avoid exposure to direct sunlight, temperature extremes, and moisture.

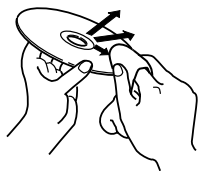

To clean the disc

Wipe the disc with a soft cloth in a straight line from center to edge.



DO NOT use any solvent — such as conventional record cleaner, spray, thinner, or benzine — to clean the disc.

Handling cassette tapes

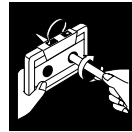

- If the tape is loose in its cassette, take up the slack by inserting a pencil in one of the reels and rotating.
- If the tape is loose, it may get stretched, cut, or caught in the cassette.

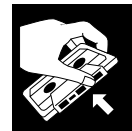

- Be careful not to touch the tape surface.



- Avoid the following places to store the tape:
 - In dusty places
 - In direct sunlight or heat
 - In moist areas
 - Near a magnet

Cleaning the unit

• Stains on the unit

Should be wiped off with a soft cloth. If the unit is heavily stained, wipe it with a cloth soaked in water-diluted neutral detergent and wrung well, then wipe clean with a dry cloth.

• Since the unit may deteriorate in quality, become damaged or suffer surface wear, be careful about the following:

- DO NOT wipe it with a hard cloth.
- DO NOT wipe it with excessive force.
- DO NOT wipe it with thinner or benzine.
- DO NOT apply any volatile substance such as insecticides to it.
- DO NOT allow any rubber or plastic to remain in contact with it for a long time.

Troubleshooting



If you have a problem with your unit, check this list for a possible solution before calling for service.

If you cannot solve the problem from the hints given here, or the unit has been physically damaged, call a qualified person, such as your dealer, for service.

Symptom	Cause	Action
Unable to cancel the display demonstration.	Other buttons will pressed to cancel the display demonstration.	Press CANCEL/DEMO on the unit. (See page 9.)
No sound is heard.	Connections are incorrect or loose.	Check all connections and make corrections. (See pages 6 to 9.)
Hard to listen to broadcasts because of noise.	<ul style="list-style-type: none"> Antennas are disconnected. The AM loop antenna is too close to the unit. The FM antenna is not properly extended and positioned. 	<ul style="list-style-type: none"> Reconnect the antennas correctly and securely. Change the position and direction of the AM loop antenna. Extend the FM antenna at the best position.
The disc sound is discontinuous.	The disc is scratched or dirty.	Clean or replace the disc. (See page 33.)
The disc tray does not open or close.	<ul style="list-style-type: none"> The AC power cord is not plugged in. Trays are locked. 	<ul style="list-style-type: none"> Plug the AC power cord. Unlock the trays. (See page 17.)
The disc does not play.	The disc is placed upside down.	Place the disc with the label side up.
The cassette holders cannot be opened.	Power supply from the AC power cord has been cut off while the tape was running.	Turn on the unit.
Impossible to record.	Small tabs on the back of the cassette are removed.	Cover the holes with adhesive tape.
Stereo effect is lost.	Vocal Masking is activated.	Cancel the Vocal Masking. (See page 27.)
Operations are disabled.	The built-in microprocessor may have malfunctioned due to external electrical interference.	Unplug the AC power cord and then plug it back in.
Unable to operate the unit from the remote control.	<ul style="list-style-type: none"> The path between the remote control and the remote sensor on the unit is blocked. The batteries are exhausted. 	<ul style="list-style-type: none"> Remove the obstruction. Replace the batteries.

Specifications

Design and specifications are subject to change without notice.

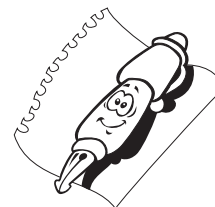

CA-MXG950V (Silver Colour) CA-MXGA9V (Silver Colour)

Amplifier section

Output Power

SUBWOOFERS: 88 W per channel, min. RMS, both channels driven into 6 Ω at 63 Hz with no more than 0.9% total harmonic distortion.

MAIN SPEAKERS: 28 W per channel, min. RMS, both channels driven into 6 Ω at 1 kHz with no more than 0.9% total harmonic distortion.

Audio input sensitivity/Impedance

(Measured at 1 kHz, with tape recording signal 300 mV)

AUX: 390 mV/50 k Ω

MIC 1/2: 3.0 mV/5 k Ω

Digital output: CD OPTICAL DIGITAL OUTPUT

Signal wave length: 660 nm

Output level: -15 dBm to -12 dBm

Speakers/Impedance:

SUBWOOFERS: 6 Ω - 16 Ω

MAIN SPEAKERS: 6 Ω - 16 Ω

SURROUND SPEAKERS: 16 Ω - 32 Ω

Tuner

FM tuning range: 87.50 MHz - 108.00 MHz

AM tuning range:

For Saudi Arabia:

At 9 kHz intervals: 531 kHz - 1 602 kHz

At 10 kHz intervals: 530 kHz - 1 600 kHz

For other countries:

At 9 kHz intervals: 531 kHz - 1 710 kHz

At 10 kHz intervals: 530 kHz - 1 710 kHz

CD player

CD capacity: 3 CDs

Dynamic range: 85 dB

Signal-to-noise ratio: 90 dB

Wow and flutter: Immeasurable

Cassette deck

Frequency response

Normal (type I): 50 Hz - 14 000 Hz

Wow and flutter: 0.15% (WRMS)

General

Power requirement: AC 110 V / AC 127 V / AC 220 V / AC 230 V - AC 240 V \sim (adjustable with the voltage selector), 50 Hz / 60 Hz

Power consumption: 170 W (at operation)
25 W (on standby)

Dimensions (approx.): 265 mm x 335 mm x 401 mm (W/H/D)
(10⁷/₁₆ in. x 13¹/₄ in. x 15¹³/₁₆ in.)

Mass (approx.): 10.0 kg (22.1 lbs)

Supplied accessories

See page 6.

CA-MXG880V (Gold Colour) CA-MXG850V (Silver Colour) CA-MXGA8V (Silver Colour)

Amplifier section

Output Power

SUBWOOFERS: 68 W per channel, min. RMS, both channels driven into 6 Ω at 63 Hz with no more than 0.9% total harmonic distortion.

MAIN SPEAKERS: 22 W per channel, min. RMS, both channels driven into 6 Ω at 1 kHz with no more than 0.9% total harmonic distortion.

Audio input sensitivity/Impedance

(Measured at 1 kHz, with tape recording signal 300 mV)

AUX: 390 mV/50 k Ω

MIC 1/2: 3.0 mV/5 k Ω

Digital output: CD OPTICAL DIGITAL OUTPUT

Signal wave length: 660 nm

Output level: -15 dBm to -12 dBm

Speakers/Impedance:

SUBWOOFERS: 6 Ω - 16 Ω

MAIN SPEAKERS: 6 Ω - 16 Ω

SURROUND SPEAKERS: 16 Ω - 32 Ω

Tuner

FM tuning range: 87.50 MHz - 108.00 MHz

AM tuning range:

For Saudi Arabia:

At 9 kHz intervals: 531 kHz - 1 602 kHz

At 10 kHz intervals: 530 kHz - 1 600 kHz

For other countries:

At 9 kHz intervals: 531 kHz - 1 710 kHz

At 10 kHz intervals: 530 kHz - 1 710 kHz

CD player

CD capacity: 3 CDs

Dynamic range: 85 dB

Signal-to-noise ratio: 90 dB

Wow and flutter: Immeasurable

Cassette deck

Frequency response

Normal (type I): 50 Hz - 14 000 Hz

Wow and flutter: 0.15% (WRMS)

General

Power requirement: AC 110 V / AC 127 V / AC 220 V / AC 230 V - AC 240 V \sim (adjustable with the voltage selector), 50 Hz / 60 Hz

Power consumption: 130 W (at operation)
25 W (on standby)

Dimensions (approx.): 265 mm x 335 mm x 401 mm (W/H/D)
(10⁷/₁₆ in. x 13¹/₄ in. x 15¹³/₁₆ in.)

Mass (approx.): 10.0 kg (22.1 lbs)

Supplied accessories

See page 6.

CA-MXG780V (Gold Colour) CA-MXG750V (Silver Colour) CA-MXGA7V (Silver Colour)

Amplifier section

Output Power

MAIN SPEAKERS: 68 W per channel, min. RMS, both channels driven into 6 Ω at 1 kHz with no more than 0.9% total harmonic distortion.

Audio input sensitivity/Impedance

(Measured at 1 kHz, with tape recording signal 300 mV)

AUX: 390 mV/50 k Ω

MIC 1/2: 3.0 mV/5 k Ω

Digital output: CD OPTICAL DIGITAL OUTPUT

Signal wave length: 660 nm

Output level: -15 dBm to -12 dBm

Speakers/Impedance:

MAIN SPEAKERS: 6 Ω - 16 Ω

SURROUND SPEAKERS: 16 Ω - 32 Ω

Tuner

FM tuning range: 87.50 MHz - 108.00 MHz

AM tuning range:

For Saudi Arabia:

At 9 kHz intervals: 531 kHz - 1 602 kHz

At 10 kHz intervals: 530 kHz - 1 600 kHz

For other countries:

At 9 kHz intervals: 531 kHz - 1 710 kHz

At 10 kHz intervals: 530 kHz - 1 710 kHz

CD player

CD capacity: 3 CDs

Dynamic range: 85 dB

Signal-to-noise ratio: 90 dB

Wow and flutter: Immeasurable

Cassette deck

Frequency response

Normal (type I): 50 Hz - 14 000 Hz

Wow and flutter: 0.15% (WRMS)

General

Power requirement: AC 110 V / AC 127 V / AC 220 V / AC 230 V - AC 240 V \sim (adjustable with the voltage selector), 50 Hz / 60 Hz

Power consumption: 110 W (at operation)
25 W (on standby)

Dimensions (approx.): 265 mm x 335 mm x 401 mm (W/H/D)
(10⁷/₁₆ in. x 13¹/₄ in. x 15¹³/₁₆ in.)

Mass (approx.): 10.0 kg (22.1 lbs)

Supplied accessories

See page 6.

Mains (AC) Line Instruction (not applicable for Europe, U.S.A., Canada, Australia, and U.K.)

主 (AC) 电源线路说明 (不适用于欧洲、美国、加拿大、澳洲及英国型号)

تعليمات خط التيار الكهربائي الرئيسي (المتردد) (لا تنطبق على اوروبا والولايات المتحدة الأمريكية وكندا واستراليا و المملكة المتحدة)

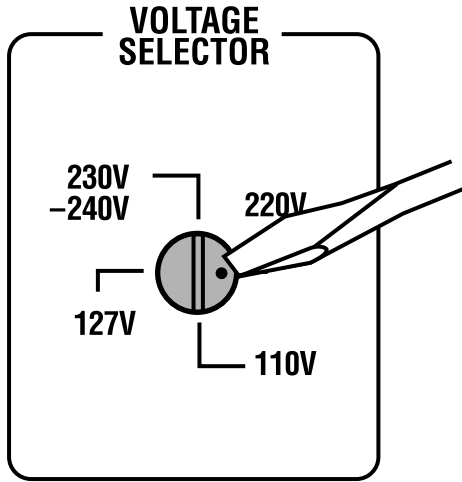

IMPORTANT for mains (AC) line

BEFORE PLUGGING IN, do check that your mains (AC) line voltage corresponds with the position of the voltage selector switch provided on the outside of this equipment and, if different, reset the voltage selector switch, to prevent from damage or risk of fire/electric shock.

有关主 (AC) 电源线路的重要事项

接插电源以前，务请检查当地的主(AC)电源线路电压是否和位于本机外面的电压选择开关设定的位置一致。如果不一致，即重新设定电压选择开关使符合当地电压，以免损坏机器或引起火灾/触电的危险。

هام من اجل خط التيار الكهربائي الرئيسي (المتردد)
قبل ادخال قاييس الطاقة الكهربائية، تأكد من تطليو منتخب فولطية التيار الكهربائي الرئيسي (المتردد) الموجود على خلفية الجهاز مع فولطية التيار الكهربائي في بلدك. في حالة عدم التطايو، اعد ضبط مفتاح منتخب الفولطية على فولطية التيار الكهربائي المتردد في بلدك. عدم عمل ذلك، يمكن يؤدي الى حصول ضرر او حريق او صدمة كهربائية.

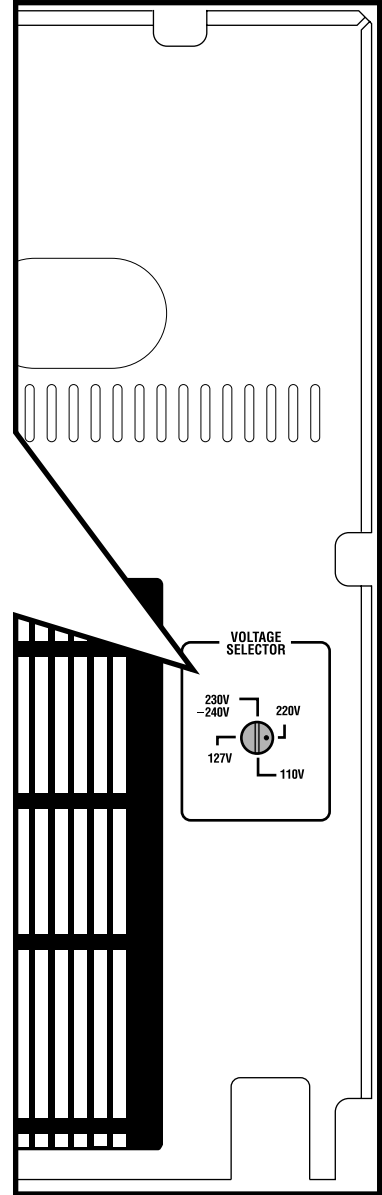

JVC

VICTOR COMPANY OF JAPAN, LIMITED